

---

# TABLE OF CONTENTS

---

## CUMULATIVE TABLE OF VIRGINIA ADMINISTRATIVE CODE SECTIONS ADOPTED, AMENDED, OR REPEALED

Cumulative Table.....739

## PETITIONS FOR RULEMAKING

### DEPARTMENT OF CONSERVATION AND RECREATION

Virginia State Parks Regulations. (4 VAC 5-30).....755

Virginia State Parks Regulations. (4 VAC 5-30).....755

## NOTICES OF INTENDED REGULATORY ACTION

### TITLE 6. CRIMINAL JUSTICE AND CORRECTIONS

State Board of Juvenile Justice.....756

### TITLE 12. HEALTH

State Board of Health.....756

Department of Medical Assistance Services.....757

### TITLE 18. PROFESSIONAL AND OCCUPATIONAL LICENSING

Board of Accountancy .....757

### TITLE 22. SOCIAL SERVICES

Department of Rehabilitative Services .....757

State Board of Social Services .....758

## PROPOSED REGULATIONS

### TITLE 4. CONSERVATION AND NATURAL RESOURCES

#### BOARD OF GAME AND INLAND FISHERIES

Definitions and Miscellaneous: Importation, Possession, Sale, Etc., of Animals (amending 4 VAC 15-30-40).....760

### TITLE 12. HEALTH

#### STATE MENTAL HEALTH, MENTAL RETARDATION AND SUBSTANCE ABUSE SERVICES BOARD

Public Participation Guidelines (amending 12 VAC 35-11-10 through 12 VAC 35-11-90; adding 12 VAC 35-11-15 and 12 VAC 35-11-110; repealing 12 VAC 35-11-100).....762

### TITLE 14. INSURANCE

#### STATE CORPORATION COMMISSION

##### Bureau of Insurance

Rules Governing Long-Term Care Insurance (amending 14 VAC 5-200-20, 14 VAC 5-200-30, 14 VAC 5-200-40, 14 VAC 5-200-60, 14 VAC 5-200-75, 14 VAC 5-200-150, and 14 VAC 5-200-200; adding 14 VAC 5-200-77 and 14 VAC 5-200-153)..... 766

### TITLE 24. TRANSPORTATION AND MOTOR VEHICLES

#### COMMONWEALTH TRANSPORTATION BOARD

Minimum Standards of Entrances to State Highways (amending 24 VAC 30-71-10, 24 VAC 30-71-70, 24 VAC 30-71-80, 24 VAC 30-71-90, 24 VAC 30-71-100, 24 VAC 30-71-110, 24 VAC 30-71-120, 24 VAC 30-71-130, 24 VAC 30-71-150, 24 VAC 30-71-160, and 24 VAC 30-71-170)..... 777

## FINAL REGULATIONS

### TITLE 4. CONSERVATION AND NATURAL RESOURCES

#### DEPARTMENT OF GAME AND INLAND FISHERIES

Definitions and Miscellaneous: Importation, Possession, Sale, etc., of Animals (amending 4 VAC 15-30-40)..... 805

Fish: Fishing Generally (amending 4 VAC 15-320-40 and 4 VAC 15-320-50; adding 4 VAC 15-320-25; repealing 4 VAC 15-320-20 and 4 VAC 15-320-30)..... 805

Fish: Trout Fishing (amending 4 VAC 15-330-10, 4 VAC 15-330-100, 4 VAC 15-330-120, 4 VAC 15-330-160, and 4 VAC 15-330-190)..... 805

Fish: Seines and Nets (amending 4 VAC 15-340-60)..... 806

Fish: Gigs, Grab Hooks, Trotlines, Snares, etc. (amending 4 VAC 15-350-30)..... 806

Fish: Aquatic Invertebrates, Amphibians, Reptiles, and Nongame Fish (amending 4 VAC 15-360-10)..... 806

Watercraft: In General (amending 4 VAC 15-370-50; adding 4 VAC 15-370-51, 4 VAC 15-370-70, and 4 VAC 15-370-80; repealing 4 VAC 15-370-10 and 4 VAC 15-370-30)..... 807

Watercraft: Motorboat Numbering (amending 4 VAC 15-380-30, 4 VAC 15-380-40, 4 VAC 15-380-50, and 4 VAC 15-380-70; adding 4 VAC 15-380-80 through 4 VAC 15-380-130; repealing 4 VAC 15-380-10, 4 VAC 15-380-20, and 4 VAC 15-380-60)..... 807

Watercraft: Safe and Reasonable Operation of Vessels (amending 4 VAC 15-390-10, 4 VAC 15-390-20, 4 VAC 15-390-30, 4 VAC 15-390-50, 4 VAC 15-390-70, 4 VAC 15-390-90, 4 VAC 15-390-100, 4 VAC 15-390-110, and 4 VAC 15-390-130; adding 4 VAC 15-390-11, 4 VAC 15-390-140, 4 VAC 15-390-150, and 4 VAC 15-390-160)..... 808

---

# Table of Contents

---

Watercraft: Accident and Casualty Reporting (amending 4 VAC 15-400-20 and 4 VAC 15-400-30; adding 4 VAC 15-400-50)..... 808

Watercraft: Navigation Lights and Shapes (adding 4 VAC 15-420-10 through 4 VAC 15-420-120)..... 808

Watercraft: Safety Equipment Requirements (adding 4 VAC 15-430-10 through 4 VAC 15-430-220)..... 809

Watercraft: Commercial Vessel Safety Equipment Requirements (adding 4 VAC 15-440-10 through 4 VAC 15-440-60)..... 809

## **MARINE RESOURCES COMMISSION**

Pertaining to Restrictions on Oyster Harvest (amending 4 VAC 20-720-80)..... 809

## **EMERGENCY REGULATIONS**

### TITLE 4. CONSERVATION AND NATURAL RESOURCES

#### **MARINE RESOURCES COMMISSION**

Pertaining to Importation of Fish, Shellfish or Crustacea (amending 4 VAC 20-754-10, 4 VAC 20-754-20, and 4 VAC 20-754-30)..... 811

## **GOVERNOR**

### EXECUTIVE ORDER

Establishing the Northern Virginia and Hampton Roads Transportation Accountability Committees. (37-2002)..... 813

## **FORMS**

### TITLE 14. INSURANCE

#### **STATE CORPORATION COMMISSION**

Rules Governing Surplus Lines Insurance. (14 VAC 5-350)..... 814

## **GENERAL NOTICES/ERRATA**

#### **STATE CORPORATION COMMISSION**

##### **Bureau of Insurance**

### ADMINISTRATIVE LETTER

Insurer Affiliation Survey. (2002-13)..... 817

#### **STATE LOTTERY DEPARTMENT**

### DIRECTOR'S ORDERS

Virginia's Instant Game Lottery 531; "Millionaire Party II" Final

Rules for Game Operation (effective 9/23/02). (46-02)..... 817

Virginia's Instant Game Lottery 240; "Diamond Card" Final Rules for Game Operation (effective 9/30/02). (47-02)..... 817

Virginia's Instant Game Lottery 527; "Money Talks" Final Rules for Game Operation (effective 9/30/02). (48-02)..... 817

Virginia's Instant Game Lottery 528; "\$20,000 Cashword" Final Rules for Game Operation (effective 9/30/02). (49-02)..... 817

Virginia's Instant Game Lottery 535; "Season's Greetings" Final Rules for Game Operation (effective 9/30/02). (50-02)..... 817

Virginia's Instant Game Lottery 536; "Winter Action" Final Rules for Game Operation (effective 9/30/02). (51-02)..... 817

Virginia's Instant Game Lottery 532; "Blazin' Eights" Final Rules for Game Operation (effective 10/11/02). (54-02)..... 817

Certain Virginia Instant Game Lotteries; End of Games. (45-02)..... 817

Certain Virginia Instant Game Lotteries; End of Games. (53-02)..... 818

#### **BOARD OF PHYSICAL THERAPY**

Notice of Periodic Review of Regulations ..... 818

#### **VIRGINIA CODE COMMISSION**

Notice to State Agencies..... 818

Forms for Filing Material for Publication in *The Virginia Register of Regulations*..... 818

### ERRATA

#### **STATE CORPORATION COMMISSION**

Rules Governing Retail Access to Competitive Energy Services. (20 VAC 5-312)..... 819

## **CALENDAR OF EVENTS**

### EXECUTIVE

Open Meetings and Public Hearings ..... 820

### INDEPENDENT

Open Meetings and Public Hearings ..... 839

### LEGISLATIVE

Open Meetings and Public Hearings ..... 839

### CHRONOLOGICAL LIST

Open Meetings..... 840

Public Hearings..... 843

# CUMULATIVE TABLE OF VIRGINIA ADMINISTRATIVE CODE SECTIONS ADOPTED, AMENDED, OR REPEALED

The table printed below lists regulation sections, by Virginia Administrative Code (VAC) title, that have been amended, added or repealed in the *Virginia Register* since the regulations were originally published or last supplemented in VAC (the Spring 2002 VAC Supplement includes final regulations published through *Virginia Register* Volume 18, Issue 11, dated February 11, 2002). Emergency regulations, if any, are listed, followed by the designation "emer," and errata pertaining to final regulations are listed. Proposed regulations are not listed here. The table lists the sections in numerical order and shows action taken, the volume, issue and page number where the section appeared, and the effective date of the section.

SECTION NUMBER	ACTION	CITE	EFFECTIVE DATE
<b>Title 2. Agriculture</b>			
2 VAC 5-400-10	Amended	18:21 VA.R. 2768	8/1/02
2 VAC 5-400-20	Amended	18:21 VA.R. 2768	8/1/02
2 VAC 5-400-30	Amended	18:21 VA.R. 2768	8/1/02
2 VAC 5-400-50	Amended	18:21 VA.R. 2768	8/1/02
2 VAC 5-400-80	Amended	18:21 VA.R. 2768	8/1/02
2 VAC 5-400-90	Added	18:21 VA.R. 2768	8/1/02
2 VAC 5-610-10 through 2 VAC 5-610-80	Amended	18:21 VA.R. 2768	8/1/02
<b>Title 3. Alcoholic Beverages</b>			
3 VAC 5-20-10	Amended	18:23 VA.R. 3094	8/28/02
3 VAC 5-20-60	Amended	18:23 VA.R. 3095	8/28/02
3 VAC 5-30-60	Amended	18:23 VA.R. 3095	8/28/02
3 VAC 5-50-170	Amended	18:23 VA.R. 3096	8/28/02
3 VAC 5-60-80	Amended	18:23 VA.R. 3096	8/28/02
3 VAC 5-70-20	Amended	18:23 VA.R. 3097	8/28/02
3 VAC 5-70-90	Amended	18:23 VA.R. 3097	8/28/02
<b>Title 4. Conservation and Natural Resources</b>			
4 VAC 5-35-10 through 4 VAC 5-35-50	Repealed	18:14 VA.R. 1800	4/25/02
4 VAC 5-36-10 through 4 VAC 5-36-210	Added	18:14 VA.R. 1800-1827	4/25/02
4 VAC 15-20-160	Amended	19:1 VA.R. 102	10/23/02
4 VAC 15-380-60 emer	Repealed	18:23 VA.R. 3102	7/1/02-6/30/03
4 VAC 15-380-120 emer	Added	18:23 VA.R. 3102	7/1/02-6/30/03
4 VAC 20-252-150	Amended	18:21 VA.R. 2836	5/29/02-6/27/02
4 VAC 20-252-150	Amended	18:22 VA.R. 2927	6/19/02
4 VAC 20-270-30	Amended	18:14 VA.R. 1827	3/5/02
4 VAC 20-270-40	Amended	18:14 VA.R. 1828	3/5/02
4 VAC 20-270-55	Amended	18:14 VA.R. 1828	3/5/02
4 VAC 20-270-56	Added	18:14 VA.R. 1828	3/5/02
4 VAC 20-430-20	Amended	19:3 VA.R. 432	10/1/02
4 VAC 20-430-50	Amended	18:18 VA.R. 2287	5/1/02
4 VAC 20-430-60	Amended	18:18 VA.R. 2287	5/1/02
4 VAC 20-560-20	Erratum	18:14 VA.R. 1911	--
4 VAC 20-560-20 emer	Amended	18:14 VA.R. 1904	3/4/02-3/31/02
4 VAC 20-560-20	Amended	18:16 VA.R. 2054	4/1/02
4 VAC 20-560-50 emer	Amended	18:14 VA.R. 1905	3/4/02-3/31/02
4 VAC 20-560-50	Amended	18:16 VA.R. 2055	4/1/02
4 VAC 20-562-10 through 4 VAC 20-562-50 emer	Added	18:25 VA.R. 3570	8/16/02-8/30/02
4 VAC 20-610-60	Amended	18:25 VA.R. 3548	8/1/02
4 VAC 20-620-20	Amended	18:14 VA.R. 1828	3/5/02
4 VAC 20-620-40	Amended	18:12 VA.R. 1646	1/31/02
4 VAC 20-620-50	Amended	18:14 VA.R. 1828	3/5/02
4 VAC 20-620-50	Amended	18:21 VA.R. 2836	6/1/02-6/30/02
4 VAC 20-620-50	Amended	18:22 VA.R. 2927	6/19/02
4 VAC 20-620-60	Amended	18:14 VA.R. 1829	3/5/02
4 VAC 20-620-60	Erratum	18:21 VA.R. 2846	--

## Cumulative Table of VAC Sections Adopted, Amended, or Repealed

SECTION NUMBER	ACTION	CITE	EFFECTIVE DATE
4 VAC 20-620-60	Amended	18:21 VA.R. 2836	6/1/02-6/30/02
4 VAC 20-620-60	Amended	18:22 VA.R. 2928	6/19/02
4 VAC 20-620-70	Amended	18:14 VA.R. 1829	3/5/02
4 VAC 20-620-70	Amended	18:21 VA.R. 2837	6/1/02-6/30/02
4 VAC 20-620-70	Amended	18:22 VA.R. 2928	6/19/02
4 VAC 20-670-30 emer	Amended	18:22 VA.R. 2935	6/20/02-7/20/02
4 VAC 20-670-30	Amended	18:25 VA.R. 3550	8/1/02
4 VAC 20-720-20	Amended	19:3 VA.R. 432	10/1/02
4 VAC 20-720-40	Amended	19:3 VA.R. 433	10/1/02
4 VAC 20-720-47 emer	Added	18:12 VA.R. 1697	2/1/02-2/28/02
4 VAC 20-720-50 through 4 VAC 20-720-80	Amended	19:3 VA.R. 434-436	10/1/02
4 VAC 20-752-10	Amended	18:21 VA.R. 2769	6/1/02
4 VAC 20-752-20	Amended	18:21 VA.R. 2769	6/1/02
4 VAC 20-752-20 emer	Amended	18:24 VA.R. 3300	7/15/02-8/14/02
4 VAC 20-752-20	Amended	19:1 VA.R. 102	9/1/02
4 VAC 20-752-30	Amended	18:21 VA.R. 2769	6/1/02
4 VAC 20-754-30 emer	Amended	19:1 VA.R. 137	8/28/02-9/27/02
4 VAC 20-754-30	Amended	19:3 VA.R. 440	9/26/02
4 VAC 20-910-45	Amended	18:21 VA.R. 2769	6/1/02
4 VAC 20-910-45	Erratum	18:21 VA.R. 2846	--
4 VAC 20-950-30	Amended	18:14 VA.R. 1829	3/4/02
4 VAC 20-950-40	Amended	18:14 VA.R. 1829	3/4/02
4 VAC 20-950-45	Amended	18:12 VA.R. 1647	1/31/02
4 VAC 20-950-45	Amended	18:14 VA.R. 1830	3/4/02
4 VAC 20-950-45	Amended	18:16 VA.R. 2055	4/1/02
4 VAC 50-20-30	Amended	18:14 VA.R. 1831	7/1/02
4 VAC 50-20-50	Amended	18:14 VA.R. 1832	7/1/02
4 VAC 50-20-50	Erratum	18:17 VA.R. 2183	--
4 VAC 50-20-70	Amended	18:14 VA.R. 1832	7/1/02
4 VAC 50-20-120	Amended	18:14 VA.R. 1834	7/1/02
4 VAC 50-20-220	Amended	18:14 VA.R. 1834	7/1/02
4 VAC 50-20-320	Amended	18:14 VA.R. 1835	7/1/02
<b>Title 6. Criminal Justice and Corrections</b>			
6 VAC 15-40-10	Amended	18:20 VA.R. 2583	7/17/02
6 VAC 15-40-40	Amended	18:20 VA.R. 2583	7/17/02
6 VAC 15-40-90 through 6 VAC 15-40-130	Amended	18:20 VA.R. 2583	7/17/02
6 VAC 15-40-150	Amended	18:20 VA.R. 2584	7/17/02
6 VAC 15-40-155	Added	18:20 VA.R. 2583	7/17/02
6 VAC 15-40-160	Amended	18:20 VA.R. 2585	7/17/02
6 VAC 15-40-280	Amended	18:20 VA.R. 2583	7/17/02
6 VAC 15-40-290	Amended	18:20 VA.R. 2583	7/17/02
6 VAC 15-40-360 through 6 VAC 15-40-390	Amended	18:20 VA.R. 2583	7/17/02
6 VAC 15-40-393	Added	18:20 VA.R. 2585	7/17/02
6 VAC 15-40-395	Added	18:20 VA.R. 2585	7/17/02
6 VAC 15-40-400	Amended	18:20 VA.R. 2583	7/17/02
6 VAC 15-40-410	Amended	18:20 VA.R. 2583	7/17/02
6 VAC 15-40-450	Amended	18:20 VA.R. 2583	7/17/02
6 VAC 15-40-460	Amended	18:20 VA.R. 2583	7/17/02
6 VAC 15-40-470	Amended	18:20 VA.R. 2583	7/17/02
6 VAC 15-40-490	Amended	18:20 VA.R. 2583	7/17/02
6 VAC 15-40-520	Amended	18:20 VA.R. 2585	7/17/02
6 VAC 15-40-540 through 6 VAC 15-40-580	Amended	18:20 VA.R. 2583	7/17/02
6 VAC 15-40-620	Amended	18:20 VA.R. 2583	7/17/02
6 VAC 15-40-640 through 6 VAC 15-40-670	Amended	18:20 VA.R. 2583	7/17/02
6 VAC 15-40-690	Amended	18:20 VA.R. 2583	7/17/02
6 VAC 15-40-740	Amended	18:20 VA.R. 2583	7/17/02

## Cumulative Table of VAC Sections Adopted, Amended, or Repealed

SECTION NUMBER	ACTION	CITE	EFFECTIVE DATE
6 VAC 15-40-800 through 6 VAC 15-40-830	Amended	18:20 VA.R. 2583	7/17/02
6 VAC 15-40-833	Added	18:20 VA.R. 2583	7/17/02
6 VAC 15-40-835	Added	18:20 VA.R. 2583	7/17/02
6 VAC 15-40-840	Amended	18:20 VA.R. 2585	7/17/02
6 VAC 15-40-870	Amended	18:20 VA.R. 2585	7/17/02
6 VAC 15-40-900	Amended	18:20 VA.R. 2583	7/17/02
6 VAC 15-40-910	Amended	18:20 VA.R. 2583	7/17/02
6 VAC 15-40-920	Amended	18:20 VA.R. 2583	7/17/02
6 VAC 15-40-940 through 6 VAC 15-40-970	Amended	18:20 VA.R. 2583	7/17/02
6 VAC 15-40-1020	Amended	18:20 VA.R. 2583	7/17/02
6 VAC 15-40-1030	Amended	18:20 VA.R. 2583	7/17/02
6 VAC 15-40-1040	Amended	18:20 VA.R. 2583	7/17/02
6 VAC 15-40-1070	Amended	18:20 VA.R. 2583	7/17/02
6 VAC 15-40-1080	Amended	18:20 VA.R. 2583	7/17/02
6 VAC 15-40-1100	Amended	18:20 VA.R. 2583	7/17/02
6 VAC 15-40-1110	Repealed	18:20 VA.R. 2583	7/17/02
6 VAC 15-40-1130	Repealed	18:20 VA.R. 2583	7/17/02
6 VAC 15-40-1190	Amended	18:20 VA.R. 2583	7/17/02
6 VAC 15-40-1193	Added	18:20 VA.R. 2585	7/17/02
6 VAC 15-40-1195	Added	18:20 VA.R. 2585	7/17/02
6 VAC 15-40-1200	Amended	18:20 VA.R. 2585	7/17/02
6 VAC 15-40-1330	Amended	18:20 VA.R. 2583	7/17/02
6 VAC 15-40-1350	Amended	18:20 VA.R. 2583	7/17/02
6 VAC 20-171-10	Amended	18:15 VA.R. 1955	5/10/02
6 VAC 20-171-50	Amended	18:15 VA.R. 1957	5/10/02
6 VAC 20-171-120	Amended	18:15 VA.R. 1958	5/10/02
6 VAC 20-171-200	Amended	18:15 VA.R. 1958	5/10/02
6 VAC 20-171-220	Amended	18:15 VA.R. 1959	5/10/02
6 VAC 20-171-230	Amended	18:15 VA.R. 1960	5/10/02
6 VAC 20-171-240	Amended	18:15 VA.R. 1961	5/10/02
6 VAC 20-171-250	Amended	18:15 VA.R. 1961	5/10/02
6 VAC 20-171-260	Amended	18:15 VA.R. 1962	5/10/02
6 VAC 20-171-280	Amended	18:15 VA.R. 1963	5/10/02
6 VAC 20-171-310	Amended	18:15 VA.R. 1964	5/10/02
6 VAC 20-171-320	Amended	18:15 VA.R. 1964	5/10/02
6 VAC 20-171-330	Amended	18:15 VA.R. 1965	5/10/02
6 VAC 20-171-340	Amended	18:15 VA.R. 1965	5/10/02
6 VAC 20-171-350	Amended	18:15 VA.R. 1966	5/10/02
6 VAC 20-171-350	Erratum	18:20 VA.R. 2680	--
6 VAC 20-171-445	Amended	18:15 VA.R. 1968	5/10/02
6 VAC 20-171-450	Amended	18:15 VA.R. 1968	5/10/02
6 VAC 20-171-480	Amended	18:15 VA.R. 1968	5/10/02
6 VAC 20-171-520	Amended	18:15 VA.R. 1969	5/10/02
6 VAC 20-171-530	Amended	18:15 VA.R. 1969	5/10/02
6 VAC 20-171-540	Amended	18:15 VA.R. 1969	5/10/02
6 VAC 35-60-10	Amended	18:25 VA.R. 3551	11/1/02
6 VAC 35-60-20	Repealed	18:25 VA.R. 3551	11/1/02
6 VAC 35-60-30	Repealed	18:25 VA.R. 3551	11/1/02
6 VAC 35-60-40	Amended	18:25 VA.R. 3551	11/1/02
6 VAC 35-60-170	Amended	18:25 VA.R. 3551	11/1/02
6 VAC 35-60-215	Amended	18:25 VA.R. 3551	11/1/02
6 VAC 35-60-225	Added	18:25 VA.R. 3551	11/1/02
6 VAC 35-60-236	Added	18:25 VA.R. 3551	11/1/02
6 VAC 35-60-237	Added	18:25 VA.R. 3551	11/1/02
6 VAC 35-60-280	Repealed	18:25 VA.R. 3551	11/1/02
6 VAC 35-60-290	Amended	18:25 VA.R. 3551	11/1/02

## Cumulative Table of VAC Sections Adopted, Amended, or Repealed

SECTION NUMBER	ACTION	CITE	EFFECTIVE DATE
6 VAC 35-60-320	Amended	18:25 VA.R. 3551	11/1/02
6 VAC 35-60-330	Amended	18:25 VA.R. 3551	11/1/02
6 VAC 35-60-390	Amended	18:25 VA.R. 3551	11/1/02
6 VAC 35-60-400	Repealed	18:25 VA.R. 3551	11/1/02
6 VAC 35-60-410	Amended	18:25 VA.R. 3551	11/1/02
6 VAC 35-60-415	Added	18:25 VA.R. 3552	11/1/02
6 VAC 35-60-440	Repealed	18:25 VA.R. 3552	11/1/02
6 VAC 35-60-450	Amended	18:25 VA.R. 3552	11/1/02
6 VAC 35-60-460	Repealed	18:25 VA.R. 3552	11/1/02
6 VAC 35-60-480	Repealed	18:25 VA.R. 3552	11/1/02
6 VAC 35-60-490	Repealed	18:25 VA.R. 3552	11/1/02
6 VAC 35-60-495	Repealed	18:25 VA.R. 3552	11/1/02
6 VAC 35-60-500	Amended	18:25 VA.R. 3552	11/1/02
6 VAC 35-60-575	Added	18:25 VA.R. 3552	11/1/02
6 VAC 35-60-580	Amended	18:25 VA.R. 3552	11/1/02
6 VAC 35-60-600	Amended	18:25 VA.R. 3552	11/1/02
6 VAC 35-60-605	Repealed	18:25 VA.R. 3552	11/1/02
6 VAC 35-150-10	Amended	18:24 VA.R. 3284	10/1/02
6 VAC 35-150-35	Added	18:24 VA.R. 3285	10/1/02
6 VAC 35-150-55	Amended	18:24 VA.R. 3285	10/1/02
6 VAC 35-150-70 through 6 VAC 35-150-165	Amended	18:24 VA.R. 3285-3286	10/1/02
6 VAC 35-150-170	Repealed	18:24 VA.R. 3286	10/1/02
6 VAC 35-150-175	Amended	18:24 VA.R. 3286	10/1/02
6 VAC 35-150-180	Amended	18:24 VA.R. 3286	10/1/02
6 VAC 35-150-190	Amended	18:24 VA.R. 3286	10/1/02
6 VAC 35-150-200 through 6 VAC 35-150-350	Amended	18:24 VA.R. 3286-3288	10/1/02
6 VAC 35-150-360	Repealed	18:24 VA.R. 3288	10/1/02
6 VAC 35-150-370 through 6 VAC 35-150-420	Amended	18:24 VA.R. 3288	10/1/02
6 VAC 35-150-427	Added	18:24 VA.R. 3288	10/1/02
6 VAC 35-150-430	Amended	18:24 VA.R. 3288	10/1/02
6 VAC 35-150-435	Amended	18:24 VA.R. 3288	10/1/02
6 VAC 35-150-440	Amended	18:24 VA.R. 3289	10/1/02
6 VAC 35-150-450	Amended	18:24 VA.R. 3289	10/1/02
6 VAC 35-150-460	Amended	18:24 VA.R. 3289	10/1/02
6 VAC 35-150-490 through 6 VAC 35-150-540	Amended	18:24 VA.R. 3289	10/1/02
6 VAC 35-150-620 through 6 VAC 35-150-650	Amended	18:24 VA.R. 3289	10/1/02
6 VAC 35-150-670 through 6 VAC 35-150-720	Amended	18:24 VA.R. 3289	10/1/02
<b>Title 8. Education</b>			
8 VAC 20-21-10	Amended	18:12 VA.R. 1648	3/28/02
8 VAC 20-21-40	Amended	18:12 VA.R. 1649	3/28/02
8 VAC 20-21-50	Amended	18:12 VA.R. 1650	3/28/02
8 VAC 20-21-90	Amended	18:12 VA.R. 1651	3/28/02
8 VAC 20-21-100	Amended	18:12 VA.R. 1651	3/28/02
8 VAC 20-21-120	Amended	18:12 VA.R. 1652	3/28/02
8 VAC 20-21-170	Amended	18:12 VA.R. 1653	3/28/02
8 VAC 20-21-590	Amended	18:12 VA.R. 1653	3/28/02
8 VAC 20-21-660	Amended	18:12 VA.R. 1655	3/28/02
8 VAC 20-21-680	Amended	18:12 VA.R. 1656	3/28/02
8 VAC 20-80-30	Amended	18:12 VA.R. 1657	3/27/02
8 VAC 20-80-40	Amended	18:12 VA.R. 1660	3/27/02
8 VAC 20-80-54	Amended	18:12 VA.R. 1661	3/27/02
8 VAC 20-80-56	Amended	18:12 VA.R. 1664	3/27/02
8 VAC 20-80-60	Amended	18:12 VA.R. 1666	3/27/02
8 VAC 20-80-66	Amended	18:12 VA.R. 1668	3/27/02
8 VAC 20-80-70	Amended	18:12 VA.R. 1671	3/27/02
8 VAC 20-80-76	Amended	18:12 VA.R. 1676	3/27/02

# Cumulative Table of VAC Sections Adopted, Amended, or Repealed

SECTION NUMBER	ACTION	CITE	EFFECTIVE DATE
8 VAC 20-630-10 through 8 VAC 20-630-70	Added	18:12 VA.R. 1683-1684	3/28/02
8 VAC 40-70-10 through 8 VAC 40-70-50	Amended	18:21 VA.R. 2770-2773	7/1/02
8 VAC 40-120-10 through 8 VAC 40-120-50	Amended	18:21 VA.R. 2774-2778	7/31/02
8 VAC 40-120-55	Added	18:21 VA.R. 2778	7/31/02
8 VAC 40-120-60 through 8 VAC 40-120-140	Amended	18:21 VA.R. 2778-2787	7/31/02
8 VAC 40-120-190	Amended	18:21 VA.R. 2787	7/31/02
8 VAC 40-120-210 through 8 VAC 40-120-230	Amended	18:21 VA.R. 2787-2788	7/31/02
8 VAC 40-120-250	Amended	18:21 VA.R. 2788	7/31/02
8 VAC 40-120-270	Amended	18:21 VA.R. 2788	7/31/02
8 VAC 40-120-280	Amended	18:21 VA.R. 2788	7/31/02
8 VAC 40-130-10	Amended	18:21 VA.R. 2789	7/1/02
8 VAC 40-130-25	Added	18:21 VA.R. 2790	7/1/02
8 VAC 40-130-30	Amended	18:21 VA.R. 2790	7/1/02
8 VAC 40-130-50	Amended	18:21 VA.R. 2791	7/1/02
8 VAC 40-130-70	Amended	18:21 VA.R. 2791	7/1/02
8 VAC 40-130-90	Amended	18:21 VA.R. 2791	7/1/02
8 VAC 40-130-100	Repealed	18:21 VA.R. 2791	7/1/02
8 VAC 40-130-120	Amended	18:21 VA.R. 2791	7/1/02
8 VAC 40-130-130	Amended	18:21 VA.R. 2791	7/1/02
8 VAC 40-130-140	Repealed	18:21 VA.R. 2792	7/1/02
8 VAC 40-130-150 through 8 VAC 40-130-180	Amended	18:21 VA.R. 2792	7/1/02
8 VAC 40-130-200	Amended	18:21 VA.R. 2792	7/1/02
8 VAC 40-130-220	Amended	18:21 VA.R. 2793	7/1/02
<b>Title 9. Environment</b>			
9 VAC 5-10-10	Amended	18:21 VA.R. 2793	8/1/02
9 VAC 5-10-20	Amended	18:21 VA.R. 2794	8/1/02
9 VAC 5-20-180	Amended	18:21 VA.R. 2800	8/1/02
9 VAC 5-40-10	Amended	18:21 VA.R. 2802	8/1/02
9 VAC 5-40-20	Amended	18:21 VA.R. 2803	8/1/02
9 VAC 5-40-30	Amended	18:21 VA.R. 2807	8/1/02
9 VAC 5-40-40	Amended	18:21 VA.R. 2808	8/1/02
9 VAC 5-40-50	Amended	18:21 VA.R. 2809	8/1/02
9 VAC 5-40-160 through 9 VAC 5-40-230	Repealed	18:14 VA.R. 1836-1840	5/1/02
9 VAC 5-50-10	Amended	18:21 VA.R. 2810	8/1/02
9 VAC 5-50-20	Amended	18:21 VA.R. 2810	8/1/02
9 VAC 5-50-30	Amended	18:21 VA.R. 2813	8/1/02
9 VAC 5-50-40	Amended	18:21 VA.R. 2814	8/1/02
9 VAC 5-50-50	Amended	18:21 VA.R. 2815	8/1/02
9 VAC 5-50-160 through 9 VAC 5-50-230	Repealed	18:14 VA.R. 1840-1844	5/1/02
9 VAC 5-50-240	Amended	18:20 VA.R. 2586	9/1/02
9 VAC 5-50-250	Amended	18:20 VA.R. 2586	9/1/02
9 VAC 5-50-260	Amended	18:20 VA.R. 2587	9/1/02
9 VAC 5-50-320	Amended	18:20 VA.R. 2587	9/1/02
9 VAC 5-50-390	Amended	18:20 VA.R. 2587	9/1/02
9 VAC 5-60-10	Amended	18:21 VA.R. 2816	8/1/02
9 VAC 5-60-20	Amended	18:21 VA.R. 2816	8/1/02
9 VAC 5-60-30	Amended	18:21 VA.R. 2817	8/1/02
9 VAC 5-60-120 through 9 VAC 5-60-180	Amended	19:3 VA.R. 441-454	12/1/02
9 VAC 5-60-200 through 9 VAC 5-60-270	Added	18:14 VA.R. 1836-1840	5/1/02
9 VAC 5-60-200	Erratum	18:17 VA.R. 2183	--
9 VAC 5-60-300 through 9 VAC 5-60-370	Added	18:14 VA.R. 1840-1844	5/1/02
9 VAC 5-60-300	Erratum	18:17 VA.R. 2183	--
9 VAC 5-80-10	Repealed	18:20 VA.R. 2587	9/1/02
9 VAC 5-80-11	Repealed	18:20 VA.R. 2608	9/1/02
9 VAC 5-80-1100 through 9 VAC 5-80-1320	Added	18:20 VA.R. 2587-2612	9/1/02
9 VAC 5-80-1250	Erratum	18:23 VA.R. 3136	--

## Cumulative Table of VAC Sections Adopted, Amended, or Repealed

SECTION NUMBER	ACTION	CITE	EFFECTIVE DATE
9 VAC 5-80-2000 through 9 VAC 5-80-2090	Amended	18:14 VA.R. 1845-1852	5/1/02
9 VAC 5-80-2100	Repealed	18:14 VA.R. 1852	5/1/02
9 VAC 5-80-2110	Amended	18:14 VA.R. 1852	5/1/02
9 VAC 5-80-2120	Amended	18:14 VA.R. 1852	5/1/02
9 VAC 5-80-2150	Amended	18:14 VA.R. 1853	5/1/02
9 VAC 5-80-2160	Repealed	18:14 VA.R. 1853	5/1/02
9 VAC 5-80-2180	Amended	18:14 VA.R. 1853	5/1/02
9 VAC 5-80-2190	Amended	18:14 VA.R. 1853	5/1/02
9 VAC 5-80-2200	Added	18:14 VA.R. 1853	5/1/02
9 VAC 5-80-2210	Added	18:14 VA.R. 1853	5/1/02
9 VAC 5-80-2220	Added	18:14 VA.R. 1853	5/1/02
9 VAC 5-80-2230	Added	18:14 VA.R. 1853	5/1/02
9 VAC 5-80-2240	Added	18:14 VA.R. 1853	5/1/02
9 VAC 5-91-20	Amended	18:20 VA.R. 2613	10/1/02
9 VAC 5-91-30	Amended	18:20 VA.R. 2619	10/1/02
9 VAC 5-91-41	Repealed	18:20 VA.R. 2621	10/1/02
9 VAC 5-91-50	Amended	18:20 VA.R. 2621	10/1/02
9 VAC 5-91-70	Amended	18:20 VA.R. 2622	10/1/02
9 VAC 5-91-120	Amended	18:20 VA.R. 2622	10/1/02
9 VAC 5-91-160 through 9 VAC 5-91-230	Amended	18:20 VA.R. 2622-2623	10/1/02
9 VAC 5-91-260	Amended	18:20 VA.R. 2623	10/1/02
9 VAC 5-91-270	Amended	18:20 VA.R. 2623	10/1/02
9 VAC 5-91-290 through 9 VAC 5-91-340	Amended	18:20 VA.R. 2623-2625	10/1/02
9 VAC 5-91-360	Amended	18:20 VA.R. 2625	10/1/02
9 VAC 5-91-370	Amended	18:20 VA.R. 2625	10/1/02
9 VAC 5-91-380	Amended	18:20 VA.R. 2626	10/1/02
9 VAC 5-91-380	Amended	19:3 VA.R. 455	12/1/02
9 VAC 5-91-410 through 9 VAC 5-91-450	Amended	18:20 VA.R. 2626-2636	10/1/02
9 VAC 5-91-460	Repealed	18:20 VA.R. 2636	10/1/02
9 VAC 5-91-470	Repealed	18:20 VA.R. 2636	10/1/02
9 VAC 5-91-480 through 9 VAC 5-91-620	Amended	18:20 VA.R. 2636-2639	10/1/02
9 VAC 5-91-650 through 9 VAC 5-91-720	Amended	18:20 VA.R. 2639-2641	10/1/02
9 VAC 5-91-680	Erratum	18:23 VA.R. 3136	--
9 VAC 5-91-740	Amended	18:20 VA.R. 2641	10/1/02
9 VAC 5-91-750	Amended	18:20 VA.R. 2641	10/1/02
9 VAC 5-91-770	Repealed	18:20 VA.R. 2641	10/1/02
9 VAC 5-91-780	Repealed	18:20 VA.R. 2641	10/1/02
9 VAC 5-91-790	Amended	18:20 VA.R. 2641	10/1/02
9 VAC 5-91-800	Amended	18:20 VA.R. 2642	10/1/02
9 VAC 5-140-10 through 9 VAC 5-140-940	Added	18:20 VA.R. 2654-2657	7/17/02
9 VAC 5-140-20	Erratum	18:22 VA.R. 2953	--
9 VAC 5-140-60	Erratum	18:22 VA.R. 2953	--
9 VAC 5-140-430	Erratum	18:22 VA.R. 2953	--
9 VAC 5-140-860	Erratum	18:22 VA.R. 2953	--
9 VAC 5-140-870	Erratum	18:22 VA.R. 2953	--
9 VAC 5-220-10 through 9 VAC 5-220-60	Added	19:3 VA.R. 456	12/1/02
9 VAC 5-221-10 through 9 VAC 5-221-60	Added	19:3 VA.R. 456	12/1/02
9 VAC 5-510-10 through 9 VAC 5-510-250	Added	19:3 VA.R. 457-466	12/1/02
9 VAC 10-20-40	Erratum	18:13 VA.R. 1763	--
9 VAC 10-20-130	Erratum	18:13 VA.R. 1764	--
9 VAC 10-20-181	Erratum	18:13 VA.R. 1764	--
9 VAC 10-20-191	Erratum	18:13 VA.R. 1764	--
9 VAC 20-60	Erratum	18:12 VA.R. 1714	--
9 VAC 20-60-1285 emer	Amended	18:21 VA.R. 2837	7/1/02-6/30/03
9 VAC 20-60-1285	Erratum	18:25 VA.R. 3607	--
Appendix 3.1 of 9 VAC 20-90 emer	Amended	18:21 VA.R. 2838	7/1/02-6/30/03



# Cumulative Table of VAC Sections Adopted, Amended, or Repealed

SECTION NUMBER	ACTION	CITE	EFFECTIVE DATE
9 VAC 20-120-10	Amended	18:18 VA.R. 2287	6/19/02
9 VAC 20-120-20	Repealed	18:18 VA.R. 2287	6/19/02
9 VAC 20-120-40 through 9 VAC 20-120-100	Amended	18:18 VA.R. 2287	6/19/02
9 VAC 20-120-120	Amended	18:18 VA.R. 2287	6/19/02
9 VAC 20-120-130	Amended	18:18 VA.R. 2287	6/19/02
9 VAC 20-120-150 through 9 VAC 20-120-180	Amended	18:18 VA.R. 2287	6/19/02
9 VAC 20-120-200 through 9 VAC 20-120-310	Amended	18:18 VA.R. 2287	6/19/02
9 VAC 20-120-330	Amended	18:18 VA.R. 2287	6/19/02
9 VAC 20-120-340	Amended	18:18 VA.R. 2287	6/19/02
9 VAC 20-120-360	Amended	18:18 VA.R. 2287	6/19/02
9 VAC 20-120-370	Amended	18:18 VA.R. 2287	6/19/02
9 VAC 20-120-380	Amended	18:18 VA.R. 2287	6/19/02
9 VAC 20-120-390	Amended	18:18 VA.R. 2287	6/19/02
9 VAC 20-120-410 through 9 VAC 20-120-480	Amended	18:18 VA.R. 2287	6/19/02
9 VAC 20-120-500	Amended	18:18 VA.R. 2287	6/19/02
9 VAC 20-120-530	Amended	18:18 VA.R. 2287	6/19/02
9 VAC 20-120-540	Amended	18:18 VA.R. 2287	6/19/02
9 VAC 20-120-560	Amended	18:18 VA.R. 2287	6/19/02
9 VAC 20-120-590	Amended	18:18 VA.R. 2287	6/19/02
9 VAC 20-120-640	Amended	18:18 VA.R. 2287	6/19/02
9 VAC 20-120-680 through 9 VAC 20-120-760	Amended	18:18 VA.R. 2287	6/19/02
9 VAC 20-120-770 through 9 VAC 20-120-800	Repealed	18:18 VA.R. 2287	6/19/02
9 VAC 20-120-810	Amended	18:18 VA.R. 2287	6/19/02
9 VAC 20-120-835	Added	18:18 VA.R. 2287	6/19/02
9 VAC 20-120-840	Amended	18:18 VA.R. 2287	6/19/02
9 VAC 20-120-880	Amended	18:18 VA.R. 2287	6/19/02
Appendix 10.1	Repealed	18:18 VA.R. 2287	6/19/02
Appendix 10.4	Repealed	18:18 VA.R. 2287	6/19/02
9 VAC 20-160-10 through 9 VAC 20-160-40	Amended	18:18 VA.R. 2288-2290	7/1/02
9 VAC 20-160-50	Repealed	18:18 VA.R. 2290	7/1/02
9 VAC 20-160-60 through 9 VAC 20-160-120	Amended	18:18 VA.R. 2290-2292	7/1/02
9 VAC 20-160-130	Repealed	18:18 VA.R. 2292	7/1/02
9 VAC 25-20-110 emer	Amended	18:21 VA.R. 2839	7/1/02-6/30/03
9 VAC 25-20-120 emer	Amended	18:21 VA.R. 2840	7/1/02-6/30/03
9 VAC 25-20-130 emer	Amended	18:21 VA.R. 2841	7/1/02-6/30/03
9 VAC 25-31-50	Amended	18:25 VA.R. 3552	9/25/02
9 VAC 25-31-100	Amended	18:25 VA.R. 3553	9/25/02
9 VAC 25-60	Repealed	18:20 VA.R. 2657	7/17/02
9 VAC 25-180-10	Amended	19:4 VA.R. 629	12/4/02
9 VAC 25-180-20	Amended	19:4 VA.R. 629	12/4/02
9 VAC 25-180-40	Amended	19:4 VA.R. 629	12/4/02
9 VAC 25-180-50	Amended	19:4 VA.R. 629	12/4/02
9 VAC 25-180-55	Added	19:4 VA.R. 629	12/4/02
9 VAC 25-180-60	Amended	19:4 VA.R. 629	12/4/02
9 VAC 25-180-70	Amended	19:4 VA.R. 630	12/4/02
9 VAC 25-194-10	Amended	18:19 VA.R. 2452	10/15/02
9 VAC 25-194-40 through 9 VAC 25-194-70	Amended	18:19 VA.R. 2452	10/15/02
9 VAC 25-194-80	Repealed	18:19 VA.R. 2452	10/15/02
9 VAC 25-260-5	Amended	18:20 VA.R. 2658	*
9 VAC 25-260-50	Amended	17:16 VA.R. 2381	6/5/02**
9 VAC 25-260-55	Added	17:16 VA.R. 2381	6/5/02**
9 VAC 25-260-140	Amended	18:24 VA.R. 3289	*

\* 30 days after notice in the *Virginia Register* of EPA approval.

\*\* Notice of effective date published in 18:17 VA.R. 2174.

## Cumulative Table of VAC Sections Adopted, Amended, or Repealed

SECTION NUMBER	ACTION	CITE	EFFECTIVE DATE
9 VAC 25-260-140	Erratum	18:25 VA.R. 3607	--
9 VAC 25-260-155	Amended	18:24 VA.R. 3289	*
9 VAC 25-260-160	Amended	18:20 VA.R. 2658	*
9 VAC 25-260-170	Amended	18:20 VA.R. 2658	*
9 VAC 25-260-310	Amended	18:20 VA.R. 2659	*
9 VAC 25-260-390	Amended	18:20 VA.R. 2661	*
9 VAC 25-420	Repealed	18:26 VA.R. 3808	***
9 VAC 25-430	Repealed	18:26 VA.R. 3808	***
9 VAC 25-440	Repealed	18:26 VA.R. 3808	***
9 VAC 25-450	Repealed	18:26 VA.R. 3808	***
9 VAC 25-452	Repealed	18:26 VA.R. 3808	***
9 VAC 25-460	Repealed	18:26 VA.R. 3808	***
9 VAC 25-470	Repealed	18:26 VA.R. 3808	***
9 VAC 25-480	Repealed	18:26 VA.R. 3808	***
9 VAC 25-490	Repealed	18:26 VA.R. 3808	***
9 VAC 25-500	Repealed	18:26 VA.R. 3808	***
9 VAC 25-510	Repealed	18:26 VA.R. 3808	***
9 VAC 25-520	Repealed	18:26 VA.R. 3808	***
9 VAC 25-530	Repealed	18:26 VA.R. 3808	***
9 VAC 25-540	Repealed	18:26 VA.R. 3808	***
9 VAC 25-550	Repealed	18:26 VA.R. 3808	***
9 VAC 25-560	Repealed	18:26 VA.R. 3808	***
9 VAC 25-570	Repealed	18:26 VA.R. 3808	***
9 VAC 25-572	Repealed	18:26 VA.R. 3808	***
9 VAC 25-720-10 through 9 VAC 25-720-140	Added	18:26 VA.R. 3809-3852	***
9 VAC 25-750-10 through 9 VAC 25-750-50	Added	19:4 VA.R. 645-658	12/9/02
<b>Title 10. Finance and Financial Institutions</b>			
10 VAC 5-160-50	Added	18:19 VA.R. 2453	5/15/02
10 VAC 5-200-10 through 10 VAC 5-200-80	Added	18:24 VA.R. 3296-3299	7/22/02
<b>Title 11. Gaming</b>			
11 VAC 10-20-260 through 11 VAC 10-20-310	Amended	18:20 VA.R. 2661-2664	5/22/02
11 VAC 10-20-330	Amended	18:20 VA.R. 2664	5/22/02
11 VAC 10-20-340	Amended	18:20 VA.R. 2671	5/22/02
11 VAC 10-100-80	Amended	18:23 VA.R. 3097	7/1/02
11 VAC 10-100-100	Amended	18:23 VA.R. 3097	7/1/02
11 VAC 10-100-110	Repealed	18:23 VA.R. 3097	7/1/02
11 VAC 10-100-140	Repealed	18:23 VA.R. 3097	7/1/02
11 VAC 10-100-150	Amended	18:23 VA.R. 3097	7/1/02
11 VAC 10-100-150	Erratum	18:23 VA.R. 3136	--
11 VAC 10-100-151	Added	18:23 VA.R. 3097	7/1/02
11 VAC 10-100-152	Added	18:23 VA.R. 3097	7/1/02
11 VAC 10-100-170	Amended	18:23 VA.R. 3097	7/1/02
11 VAC 10-100-190	Amended	18:23 VA.R. 3097	7/1/02
11 VAC 10-110-10	Amended	18:23 VA.R. 3098	7/1/02
11 VAC 10-110-20	Amended	18:23 VA.R. 3098	7/1/02
11 VAC 10-110-40	Amended	18:23 VA.R. 3098	7/1/02
11 VAC 10-110-60	Amended	18:23 VA.R. 3098	7/1/02
11 VAC 10-110-80	Amended	18:23 VA.R. 3098	7/1/02
11 VAC 10-110-90	Amended	18:23 VA.R. 3098	7/1/02
11 VAC 10-110-150	Amended	18:23 VA.R. 3098	7/1/02
11 VAC 10-110-180	Amended	18:23 VA.R. 3098	7/1/02
11 VAC 10-120-20	Amended	18:23 VA.R. 3098	7/1/02

\* 30 days after notice in the *Virginia Register* of EPA approval.

\*\*\* Effective date suspended at publication for further public comment.

## Cumulative Table of VAC Sections Adopted, Amended, or Repealed

SECTION NUMBER	ACTION	CITE	EFFECTIVE DATE
11 VAC 10-120-40	Amended	18:23 VA.R. 3098	7/1/02
11 VAC 10-120-50	Amended	18:23 VA.R. 3098	7/1/02
11 VAC 10-120-80	Amended	18:23 VA.R. 3098	7/1/02
11 VAC 10-120-90	Repealed	18:23 VA.R. 3098	7/1/02
11 VAC 10-120-100	Amended	18:23 VA.R. 3098	7/1/02
11 VAC 10-130-10	Amended	18:20 VA.R. 2672	5/22/02
11 VAC 10-130-20	Amended	18:20 VA.R. 2673	5/22/02
11 VAC 10-130-51	Amended	18:20 VA.R. 2674	5/22/02
11 VAC 10-130-52	Added	18:20 VA.R. 2674	5/22/02
11 VAC 10-130-60	Amended	18:20 VA.R. 2674	5/22/02
11 VAC 10-130-80	Amended	19:3 VA.R. 478	9/27/02
11 VAC 10-140-10	Amended	18:23 VA.R. 3098	7/1/02
11 VAC 10-140-30	Amended	18:23 VA.R. 3098	7/1/02
11 VAC 10-140-40	Amended	18:23 VA.R. 3098	7/1/02
11 VAC 10-140-60	Amended	18:23 VA.R. 3098	7/1/02
11 VAC 10-140-130	Amended	18:23 VA.R. 3098	7/1/02
11 VAC 10-140-140	Amended	18:23 VA.R. 3098	7/1/02
11 VAC 10-140-170	Amended	18:23 VA.R. 3098	7/1/02
11 VAC 10-140-180	Amended	18:23 VA.R. 3098	7/1/02
11 VAC 10-140-310	Amended	18:23 VA.R. 3098	7/1/02
11 VAC 10-150-130	Amended	18:23 VA.R. 3099	7/1/02
11 VAC 10-150-130	Erratum	18:23 VA.R. 3136	--
11 VAC 10-150-140	Amended	18:23 VA.R. 3099	7/1/02
11 VAC 10-150-190	Added	18:23 VA.R. 3099	7/1/02
11 VAC 10-150-200	Added	18:23 VA.R. 3099	7/1/02
11 VAC 10-160-10	Amended	18:23 VA.R. 3099	7/1/02
11 VAC 10-160-20	Amended	18:23 VA.R. 3099	7/1/02
11 VAC 10-160-90	Repealed	18:23 VA.R. 3099	7/1/02
11 VAC 10-160-120 through 11 VAC 10-160-150	Amended	18:23 VA.R. 3099	7/1/02
11 VAC 10-180-10	Amended	18:19 VA.R. 2453	5/10/02
11 VAC 10-180-20	Amended	18:19 VA.R. 2454	5/10/02
11 VAC 10-180-40 through 11 VAC 10-180-90	Amended	18:19 VA.R. 2455-2462	5/10/02
11 VAC 10-180-60	Erratum	18:20 VA.R. 2681	--
<b>Title 12. Health</b>			
12 VAC 5-30	Repealed	19:3 VA.R. 478	1/1/03
12 VAC 5-31	Added	19:3 VA.R. 479-529	1/1/03
12 VAC 5-65	Repealed	18:12 VA.R. 1685	3/27/02
12 VAC 5-66-10 through 12 VAC 5-66-80	Added	18:12 VA.R. 1685-1688	3/27/02
12 VAC 5-66-10 through 12 VAC 5-66-80	Erratum	18:13 VA.R. 1764	--
12 VAC 5-410-230	Amended	19:1 VA.R. 103	11/1/02
12 VAC 5-410-230	Erratum	19:3 VA.R. 549	--
12 VAC 5-410-390	Amended	19:1 VA.R. 103	11/1/02
12 VAC 5-410-1170	Amended	19:1 VA.R. 104	11/1/02
12 VAC 5-410-1180	Amended	19:1 VA.R. 104	11/1/02
12 VAC 5-120-10 through 12 VAC 5-120-90	Added	18:16 VA.R. 2057-2058	5/22/02
12 VAC 5-475-10 through 12 VAC 5-475-90	Added	18:12 VA.R. 1691	3/27/02
12 VAC 5-520-10	Amended	18:15 VA.R. 1969	5/8/02
12 VAC 5-520-20	Amended	18:15 VA.R. 1969	5/8/02
12 VAC 5-520-30	Amended	18:15 VA.R. 1969	5/8/02
12 VAC 5-520-30	Erratum	18:18 VA.R. 2369	--
12 VAC 5-520-40 through 12 VAC 5-520-70	Repealed	18:15 VA.R. 1969	5/8/02
12 VAC 5-520-80	Amended	18:15 VA.R. 1969	5/8/02
12 VAC 5-520-90 through 12 VAC 5-520-120	Repealed	18:15 VA.R. 1969	5/8/02
12 VAC 5-520-130 through 12 VAC 5-520-210	Added	18:15 VA.R. 1969	5/8/02
12 VAC 5-590-10	Amended	18:19 VA.R. 2462	7/3/02
12 VAC 5-590-370	Amended	18:19 VA.R. 2468	7/3/02

## Cumulative Table of VAC Sections Adopted, Amended, or Repealed

SECTION NUMBER	ACTION	CITE	EFFECTIVE DATE
12 VAC 5-590-370	Erratum	18:22 VA.R. 2953	--
12 VAC 5-590-410	Amended	18:19 VA.R. 2474	7/3/02
12 VAC 5-590-420	Amended	18:19 VA.R. 2477	7/3/02
12 VAC 5-590-420	Erratum	18:22 VA.R. 2954	--
12 VAC 5-590-440	Amended	18:19 VA.R. 2490	7/3/02
12 VAC 5-590-500	Amended	18:19 VA.R. 2496	7/3/02
12 VAC 5-590-530	Amended	18:19 VA.R. 2496	7/3/02
12 VAC 5-590-540	Amended	18:19 VA.R. 2502	7/3/02
12 VAC 5-590-550	Amended	18:19 VA.R. 2504	7/3/02
12 VAC 5-590 Appendix B	Amended	18:19 VA.R. 2505	7/3/02
12 VAC 5-590 Appendix F	Amended	18:19 VA.R. 2506	7/3/02
12 VAC 5-615-10 through 12 VAC 5-615-470	Added	18:18 VA.R. 2293-2300	7/1/02
12 VAC 30-40-220	Amended	18:18 VA.R. 2304	7/1/02
12 VAC 30-40-280	Amended	18:18 VA.R. 2307	7/1/02
12 VAC 30-40-280	Amended	18:23 VA.R. 3099	9/1/02
12 VAC 30-40-290	Amended	18:18 VA.R. 2307	7/1/02
12 VAC 30-40-345	Amended	18:18 VA.R. 2308	7/1/02
12 VAC 30-50-190	Amended	18:18 VA.R. 2309	7/1/02
12 VAC 30-50-210	Amended	18:18 VA.R. 2310	7/1/02
12 VAC 30-60-300	Amended	18:18 VA.R. 2312	6/20/02
12 VAC 30-60-303	Added	18:18 VA.R. 2313	6/20/02
12 VAC 30-60-307	Added	18:18 VA.R. 2315	6/20/02
12 VAC 30-60-312	Added	18:18 VA.R. 2315	6/20/02
12 VAC 30-60-316	Added	18:18 VA.R. 2316	6/20/02
12 VAC 30-60-318	Added	18:18 VA.R. 2316	6/20/02
12 VAC 30-70-201 emer	Amended	18:26 VA.R. 3906	9/1/02-8/31/03
12 VAC 30-70-221 emer	Amended	18:22 VA.R. 2936	7/1/02-6/30/03
12 VAC 30-70-281 emer	Amended	18:22 VA.R. 2938	7/1/02-6/30/03
12 VAC 30-70-351 emer	Amended	18:22 VA.R. 2939	7/1/02-6/30/03
12 VAC 30-70-425 emer	Added	18:25 VA.R. 3571	8/1/02-7/31/03
12 VAC 30-70-426 emer	Added	18:25 VA.R. 3571	8/1/02-7/31/03
12 VAC 30-80-20	Amended	18:21 VA.R. 2818	8/1/02
12 VAC 30-80-20 emer	Amended	18:22 VA.R. 2939	7/1/02-6/30/03
12 VAC 30-80-20 emer	Amended	18:25 VA.R. 3571	8/1/02-7/31/03
12 VAC 30-80-25	Added	18:21 VA.R. 2820	8/1/02
12 VAC 30-80-30 emer	Amended	18:25 VA.R. 3573	8/1/02-7/31/03
12 VAC 30-80-30 emer	Amended	18:25 VA.R. 3576	8/1/02-7/31/03
12 VAC 30-80-40 emer	Amended	18:22 VA.R. 2941	7/1/02-6/30/03
12 VAC 30-90-10	Amended	18:18 VA.R. 2319	7/1/02
12 VAC 30-90-18 emer	Added	18:25 VA.R. 3575	8/1/02-7/31/03
12 VAC 30-90-19 emer	Amended	18:25 VA.R. 3575	8/1/02-7/31/03
12 VAC 30-90-20	Amended	18:18 VA.R. 2320	7/1/02
12 VAC 30-90-38	Amended	18:18 VA.R. 2321	7/1/02
12 VAC 30-90-40	Amended	18:18 VA.R. 2321	7/1/02
12 VAC 30-90-41	Amended	18:18 VA.R. 2321	7/1/02
12 VAC 30-90-41.1 emer	Added	18:23 VA.R. 3103	7/1/02-6/30/03
12 VAC 30-90-60	Amended	18:18 VA.R. 2324	7/1/02
12 VAC 30-90-271	Amended	18:18 VA.R. 2324	7/1/02
12 VAC 30-90-272	Amended	18:18 VA.R. 2325	7/1/02
12 VAC 30-90-280	Amended	18:18 VA.R. 2325	7/1/02
12 VAC 30-90-300	Repealed	18:18 VA.R. 2327	7/1/02
12 VAC 30-90-301	Repealed	18:18 VA.R. 2327	7/1/02
12 VAC 30-90-302	Repealed	18:18 VA.R. 2327	7/1/02
12 VAC 30-90-303	Repealed	18:18 VA.R. 2327	7/1/02
12 VAC 30-90-304	Repealed	18:18 VA.R. 2327	7/1/02
12 VAC 30-90-305	Added	18:18 VA.R. 2327	7/1/02

## Cumulative Table of VAC Sections Adopted, Amended, or Repealed

SECTION NUMBER	ACTION	CITE	EFFECTIVE DATE
12 VAC 30-90-306	Added	18:18 VA.R. 2327	7/1/02
12 VAC 30-90-306	Erratum	18:20 VA.R. 2681	--
12 VAC 30-90-307	Added	18:18 VA.R. 2328	7/1/02
12 VAC 30-110-720	Amended	18:21 VA.R. 2821	8/1/02
12 VAC 30-110-741	Amended	18:21 VA.R. 2823	8/1/02
12 VAC 30-110-831	Added	18:21 VA.R. 2823	8/1/02
12 VAC 30-120-10 emer	Amended	18:12 VA.R. 1698	2/1/02-1/31/03
12 VAC 30-120-40 emer	Amended	18:12 VA.R. 1699	2/1/02-1/31/03
12 VAC 30-120-50 emer	Amended	18:12 VA.R. 1701	2/1/02-1/31/03
12 VAC 30-120-55 emer	Added	18:12 VA.R. 1702	2/1/02-1/31/03
12 VAC 30-120-60 emer	Amended	18:12 VA.R. 1704	2/1/02-1/31/03
12 VAC 30-120-210	Repealed	18:26 VA.R. 3853	10/16/02
12 VAC 30-120-211 through 12 VAC 30-120-219	Added	18:26 VA.R. 3855-3865	10/16/02
12 VAC 30-120-220	Repealed	18:26 VA.R. 3865	10/16/02
12 VAC 30-120-221 through 12 VAC 30-120-229	Added	18:26 VA.R. 3867-3875	10/16/02
12 VAC 30-120-230	Repealed	18:26 VA.R. 3875	10/16/02
12 VAC 30-120-231 through 12 VAC 30-120-237	Added	18:26 VA.R. 3878-3883	10/16/02
12 VAC 30-120-240	Repealed	18:26 VA.R. 3883	10/16/02
12 VAC 30-120-241 through 12 VAC 30-120-249	Added	18:26 VA.R. 3885-3893	10/16/02
12 VAC 30-120-249	Erratum	19:3 VA.R. 549	--
12 VAC 30-120-250	Repealed	18:26 VA.R. 3893	10/16/02
12 VAC 30-120-360	Amended	19:3 VA.R. 530	12/1/02
12 VAC 30-120-370	Amended	19:3 VA.R. 531	12/1/02
12 VAC 30-120-380	Amended	19:3 VA.R. 531	12/1/02
12 VAC 30-120-385	Repealed	19:3 VA.R. 531	12/1/02
12 VAC 30-120-390 through 12 VAC 30-120-420	Amended	19:3 VA.R. 531	12/1/02
12 VAC 30-120-700 (emer)	Amended	19:3 VA.R. 536	10/1/02-9/30/03
12 VAC 30-120-710 (emer)	Amended	19:3 VA.R. 539	10/1/02-9/30/03
12 VAC 30-120-720 (emer)	Amended	19:3 VA.R. 539	10/1/02-9/30/03
12 VAC 30-135-10 through 12 VAC 30-135-80 emer	Added	18:25 VA.R. 3579-3580	10/1/02-9/30/03
12 VAC 30-141-90	Erratum	18:18 VA.R. 2369	--
12 VAC 30-141-10 through 12 VAC 30-141-650 emer	Adding	19:1 VA.R. 138-150	9/1/02-8/31/02
12 VAC 30-141-10 through 12 VAC 30-141-650 emer	Added	18:25 VA.R. 3580-3590	8/1/02-7/31/03
12 VAC 30-150-10 through 12 VAC 30-150-100	Added	18:17 VA.R. 2174	6/6/02
12 VAC 30-150	Erratum	18:18 VA.R. 2370	--
12 VAC 35-20	Repealed	18:12 VA.R. 1691	3/27/02
12 VAC 35-102	Repealed	18:18 VA.R. 2330	9/19/02
12 VAC 35-105-10 through 12 VAC 35-105-1410	Added	18:18 VA.R. 2331-2365	9/19/02
12 VAC 35-105-20 emer	Amended	18:25 VA.R. 3591	9/19/02-9/18/03
12 VAC 35-105-30 emer	Amended	18:25 VA.R. 3597	9/19/02-9/18/03
12 VAC 35-105-280 emer	Amended	18:25 VA.R. 3598	9/19/02-9/18/03
12 VAC 35-105-590 emer	Amended	18:25 VA.R. 3598	9/19/02-9/18/03
12 VAC 35-105-660 emer	Amended	18:25 VA.R. 3598	9/19/02-9/18/03
12 VAC 35-105-800 emer	Amended	18:25 VA.R. 3599	9/19/02-9/18/03
12 VAC 35-140	Repealed	18:12 VA.R. 1691	3/27/02
12 VAC 35-150	Repealed	18:12 VA.R. 1691	3/27/02
12 VAC 35-160	Repealed	18:12 VA.R. 1691	3/27/02
12 VAC 35-170	Repealed	18:18 VA.R. 2330	9/19/02
12 VAC 35-200-10	Amended	18:16 VA.R. 2059	5/22/02
12 VAC 35-200-20	Amended	18:16 VA.R. 2060	5/22/02
12 VAC 35-200-30	Amended	18:16 VA.R. 2061	5/22/02
<b>Title 13. Housing</b>			
13 VAC 5-51-11	Amended	18:22 VA.R. 2928	8/15/02
13 VAC 5-51-180	Amended	18:22 VA.R. 2929	8/15/02
13 VAC 5-51-181	Amended	18:22 VA.R. 2929	8/15/02
13 VAC 5-51-182	Amended	18:22 VA.R. 2930	8/15/02

## Cumulative Table of VAC Sections Adopted, Amended, or Repealed

SECTION NUMBER	ACTION	CITE	EFFECTIVE DATE
13 VAC 10-20-20	Amended	19:2 VA.R. 349	9/20/02
13 VAC 10-20-40	Amended	19:2 VA.R. 349	9/20/02
13 VAC 10-20-90	Amended	19:2 VA.R. 349	9/20/02
13 VAC 10-40-20	Amended	19:2 VA.R. 349	9/20/02
13 VAC 10-50-90	Amended	19:2 VA.R. 349	9/20/02
<b>Title 14. Insurance</b>			
14 VAC 5-70-10 through 14 VAC 5-70-40	Amended	18:22 VA.R. 2931-2932	7/1/02
14 VAC 5-70-80	Amended	18:22 VA.R. 2932	7/1/02
14 VAC 5-70-130	Amended	18:22 VA.R. 2933	7/1/02
14 VAC 5-71-10 through 14 VAC 5-71-100	Amended	19:1 VA.R. 104	9/4/02
14 VAC 5-80-160 through 14 VAC 5-80-190	Repealed	18:14 VA.R. 1896	3/31/02
14 VAC 5-140-20 through 14 VAC 5-140-90	Amended	18:21 VA.R. 2824	7/1/02
14 VAC 5-170-20	Amended	19:4 VA.R. 660	10/24/02
14 VAC 5-170-30	Amended	19:4 VA.R. 660	10/24/02
14 VAC 5-170-60	Amended	19:4 VA.R. 661	10/24/02
14 VAC 5-170-70	Amended	19:4 VA.R. 662	10/24/02
14 VAC 5-170-105	Amended	19:4 VA.R. 665	10/24/02
14 VAC 5-170-150	Amended	19:4 VA.R. 670	10/24/02
14 VAC 5-170-180	Amended	19:4 VA.R. 688	10/24/02
14 VAC 5-210-70	Amended	18:26 VA.R. 3896	9/1/02
14 VAC 5-210-90	Amended	18:26 VA.R. 3896	9/1/02
14 VAC 5-350-20	Amended	19:1 VA.R. 107	9/1/02
14 VAC 5-350-30	Amended	19:1 VA.R. 107	9/1/02
14 VAC 5-350-40 through 14 VAC 5-350-80	Repealed	19:1 VA.R. 108	9/1/02
14 VAC 5-350-85	Added	19:1 VA.R. 108	9/1/02
14 VAC 5-350-95	Added	19:1 VA.R. 108	9/1/02
14 VAC 5-350-110 through 14 VAC 5-350-140	Repealed	19:1 VA.R. 108	9/1/02
14 VAC 5-350-150	Amended	19:1 VA.R. 108	9/1/02
14 VAC 5-350-155	Added	19:1 VA.R. 108	9/1/02
14 VAC 5-350-160	Amended	19:1 VA.R. 108	9/1/02
14 VAC 5-350-165	Added	19:1 VA.R. 108	9/1/02
14 VAC 5-350-170	Repealed	19:1 VA.R. 108	9/1/02
14 VAC 5-350-180	Repealed	19:1 VA.R. 108	9/1/02
14 VAC 5-350-210	Amended	19:1 VA.R. 108	9/1/02
14 VAC 5-385-10 through 14 VAC 5-385-150	Added	19:2 VA.R. 351	10/1/02
14 VAC 5-390-20	Amended	18:12 VA.R. 1692	2/1/02
14 VAC 5-390-30	Amended	18:12 VA.R. 1692	2/1/02
14 VAC 5-390-40	Amended	18:12 VA.R. 1692	2/1/02
14 VAC 5-395-20	Amended	18:21 VA.R. 2825	6/3/02
14 VAC 5-395-30 through 14 VAC 5-395-60	Amended	18:21 VA.R. 2825	6/3/02
<b>Title 16. Labor and Employment</b>			
16 VAC 5-10-10	Amended	18:26 VA.R. 3897	11/3/02
16 VAC 5-10-20	Amended	18:26 VA.R. 3897	11/3/02
16 VAC 5-10-21	Added	18:26 VA.R. 3898	11/3/02
16 VAC 5-10-22	Added	18:26 VA.R. 3898	11/3/02
16 VAC 5-10-30	Amended	18:26 VA.R. 3898	11/3/02
16 VAC 5-20-10	Amended	18:26 VA.R. 3900	11/3/02
16 VAC 5-20-20	Amended	18:26 VA.R. 3900	11/3/02
16 VAC 5-32-10	Amended	18:26 VA.R. 3900	11/3/02
16 VAC 5-32-20	Amended	18:26 VA.R. 3900	11/3/02
16 VAC 5-60-10	Amended	18:26 VA.R. 3898	11/3/02
16 VAC 5-60-20	Amended	18:26 VA.R. 3900	11/3/02
16 VAC 5-60-40	Amended	18:26 VA.R. 3900	11/3/02
16 VAC 5-70-10	Amended	18:26 VA.R. 3900	11/3/02
16 VAC 5-70-20	Amended	18:26 VA.R. 3900	11/3/02
16 VAC 5-80-10	Amended	18:26 VA.R. 3900	11/3/02

# Cumulative Table of VAC Sections Adopted, Amended, or Repealed

SECTION NUMBER	ACTION	CITE	EFFECTIVE DATE
16 VAC 5-80-20	Amended	18:26 VA.R. 3900	11/3/02
16 VAC 5-80-30	Amended	18:26 VA.R. 3900	11/3/02
16 VAC 5-80-40	Amended	18:26 VA.R. 3900	11/3/02
<b>Title 18. Professional and Occupational Licensing</b>			
18 VAC 41-20-10 through 18 VAC 41-20-280 emer	Added	18:23 VA.R. 3103-3113	7/2/02-7/1/03
18 VAC 45-10-10	Amended	18:19 VA.R. 2508	7/8/02
18 VAC 45-10-20	Amended	18:19 VA.R. 2508	7/8/02
18 VAC 45-10-30	Amended	18:19 VA.R. 2508	7/8/02
18 VAC 45-10-50	Amended	18:19 VA.R. 2508	7/8/02
18 VAC 45-10-90	Amended	18:19 VA.R. 2508	7/8/02
18 VAC 60-20-10 emer	Amended	18:24 VA.R. 3301	7/19/02-7/18/03
18 VAC 60-20-90 emer	Amended	18:24 VA.R. 3303	7/19/02-7/18/03
18 VAC 60-20-106 emer	Added	18:24 VA.R. 3303	7/19/02-7/18/03
18 VAC 60-20-200 emer	Amended	18:24 VA.R. 3302	7/19/02-7/18/03
18 VAC 60-20-210 emer	Amended	18:24 VA.R. 3302	7/19/02-7/18/03
18 VAC 60-20-220 emer	Amended	18:24 VA.R. 3302	7/19/02-7/18/03
18 VAC 85-20-225 emer	Added	18:24 VA.R. 3307	7/19/02-7/18/03
18 VAC 85-20-280 emer	Amended	18:22 VA.R. 2943	6/19/02-6/18/03
18 VAC 85-20-285 emer	Added	18:22 VA.R. 2944	6/19/02-6/18/03
18 VAC 85-20-290 emer	Amended	18:22 VA.R. 2944	6/19/02-6/18/03
18 VAC 85-20-300 emer	Amended	18:22 VA.R. 2944	6/19/02-6/18/03
18 VAC 85-40-55 emer	Added	18:24 VA.R. 3307	7/19/02-7/18/03
18 VAC 85-50-10 emer	Amended	18:24 VA.R. 3309	7/19/02-7/18/03
18 VAC 85-50-35	Added	18:21 VA.R. 2826	7/31/02
18 VAC 85-50-40 emer	Amended	18:24 VA.R. 3309	7/19/02-7/18/03
18 VAC 85-50-56	Amended	18:21 VA.R. 2826	7/31/02
18 VAC 85-50-59 emer	Added	18:24 VA.R. 3309	7/19/02-7/18/03
18 VAC 85-50-101 emer	Amended	18:24 VA.R. 3309	7/19/02-7/18/03
18 VAC 85-50-110 emer	Amended	18:24 VA.R. 3310	7/19/02-7/18/03
18 VAC 85-50-115	Amended	18:21 VA.R. 2826	7/31/02
18 VAC 85-50-115 emer	Amended	18:24 VA.R. 3310	7/19/02-7/18/03
18 VAC 85-50-170	Repealed	18:21 VA.R. 2826	7/31/02
18 VAC 85-80-10	Amended	19:1 VA.R. 108	10/23/02
18 VAC 85-80-26	Added	19:1 VA.R. 108	10/23/02
18 VAC 85-80-35	Amended	19:1 VA.R. 108	10/23/02
18 VAC 85-80-40	Amended	19:1 VA.R. 108	10/23/02
18 VAC 85-80-45	Added	19:1 VA.R. 108	10/23/02
18 VAC 85-80-60 through 18 VAC 85-80-110	Amended	19:1 VA.R. 108	10/23/02
18 VAC 85-80-65 emer	Added	18:24 VA.R. 3307	7/19/02-7/18/03
18 VAC 85-80-120	Repealed	19:1 VA.R. 109	10/23/02
18 VAC 85-101-10	Amended	19:1 VA.R. 109	10/23/02
18 VAC 85-101-60	Amended	19:1 VA.R. 109	10/23/02
18 VAC 85-101-70	Amended	19:1 VA.R. 110	10/23/02
18 VAC 85-101-145 emer	Added	18:24 VA.R. 3308	7/19/02-7/18/03
18 VAC 85-101-150	Amended	19:1 VA.R. 110	10/23/02
18 VAC 85-110-145 emer	Added	18:24 VA.R. 3308	7/19/02-7/18/03
18 VAC 85-120-85 emer	Added	18:24 VA.R. 3308	7/19/02-7/18/03
18 VAC 90-20-200	Amended	18:21 VA.R. 2826	7/31/02
18 VAC 90-20-210	Amended	18:21 VA.R. 2826	7/31/02
18 VAC 90-20-271 emer	Added	18:24 VA.R. 3311	7/19/02-7/18/03
18 VAC 90-30-20	Amended	18:15 VA.R. 1970	5/8/02
18 VAC 90-30-100	Amended	18:15 VA.R. 1970	5/8/02
18 VAC 90-30-105	Added	18:15 VA.R. 1970	5/8/02
18 VAC 90-30-220	Amended	18:15 VA.R. 1970	5/8/02
18 VAC 90-40-20	Amended	18:15 VA.R. 1977	5/8/02
18 VAC 90-40-50	Amended	18:15 VA.R. 1977	5/8/02

## Cumulative Table of VAC Sections Adopted, Amended, or Repealed

SECTION NUMBER	ACTION	CITE	EFFECTIVE DATE
18 VAC 90-40-55	Added	18:15 VA.R. 1977	5/8/02
18 VAC 90-40-60	Amended	18:15 VA.R. 1977	5/8/02
18 VAC 90-40-130	Amended	18:15 VA.R. 1977	5/8/02
18 VAC 105-20-75 emer	Added	18:24 VA.R. 3311	7/19/02-7/18/03
18 VAC 110-20-20	Amended	18:12 VA.R. 1693	3/27/02
18 VAC 110-20-20	Amended	19:4 VA.R. 689	12/4/02
18 VAC 110-20-75 emer	Added	18:24 VA.R. 3312	7/19/02-7/18/03
18 VAC 110-20-240 emer	Amended	18:24 VA.R. 3314	7/19/02-7/18/03
18 VAC 110-20-255 emer	Added	18:24 VA.R. 3315	7/19/02-7/18/03
18 VAC 110-20-270	Amended	18:12 VA.R. 1693	3/27/02
18 VAC 110-20-275 emer	Added	18:24 VA.R. 3315	7/19/02-7/18/03
18 VAC 110-20-280	Amended	18:12 VA.R. 1693	3/27/02
18 VAC 110-20-285	Amended	18:12 VA.R. 1694	3/27/02
18 VAC 110-20-320 emer	Amended	18:24 VA.R. 3316	7/19/02-7/18/03
18 VAC 110-20-400 emer	Amended	18:24 VA.R. 3316	7/19/02-7/18/03
18 VAC 110-20-430	Amended	18:12 VA.R. 1694	3/27/02
18 VAC 110-20-430 emer	Repealed	18:24 VA.R. 3316	7/19/02-7/18/03
18 VAC 110-20-530 emer	Amended	18:24 VA.R. 3316	7/19/02-7/18/03
18 VAC 110-20-730 emer	Added	18:24 VA.R. 3317	7/19/02-7/18/03
18 VAC 110-30-15	Amended	19:4 VA.R. 691	12/4/02
18 VAC 112-20-10	Amended	19:1 VA.R. 110	10/23/02
18 VAC 112-20-130	Amended	19:1 VA.R. 110	10/23/02
18 VAC 112-20-131	Added	19:1 VA.R. 110	10/23/02
18 VAC 112-20-135	Amended	19:1 VA.R. 110	10/23/02
18 VAC 112-20-136	Added	19:1 VA.R. 110	10/23/02
18 VAC 112-20-140	Amended	19:1 VA.R. 110	10/23/02
18 VAC 115-30-140	Amended	19:1 VA.R. 110	10/23/02
18 VAC 115-60-130	Amended	19:1 VA.R. 111	10/23/02
18 VAC 125-10-10	Amended	18:12 VA.R. 1694	3/27/02
18 VAC 125-10-20	Amended	18:12 VA.R. 1694	3/27/02
18 VAC 125-10-30	Amended	18:12 VA.R. 1695	3/27/02
18 VAC 125-10-40	Amended	18:12 VA.R. 1695	3/27/02
18 VAC 125-10-60	Amended	18:12 VA.R. 1695	3/27/02
18 VAC 125-10-70	Amended	18:12 VA.R. 1695	3/27/02
18 VAC 125-10-80	Amended	18:12 VA.R. 1695	3/27/02
18 VAC 125-10-100	Amended	18:12 VA.R. 1695	3/27/02
18 VAC 125-30 (Forms)	Amended	18:15 VA.R. 1985	--
18 VAC 125-30-10 through 18 VAC 125-30-50	Amended	18:13 VA.R. 1753-1754	4/10/02
18 VAC 125-30-60	Repealed	18:13 VA.R. 1754	4/10/02
18 VAC 125-30-80	Amended	18:13 VA.R. 1755	4/10/02
18 VAC 125-30-90	Amended	18:13 VA.R. 1755	4/10/02
18 VAC 150-20-135 emer	Added	18:24 VA.R. 3320	7/19/02-7/18/03
<b>Title 20. Public Utilities and Telecommunications</b>			
20 VAC 5-300-90	Amended	18:21 VA.R. 2832	6/7/02
20 VAC 5-302-20	Amended	19:1 VA.R. 115	8/21/02
20 VAC 5-302-25	Added	19:1 VA.R. 117	8/21/02
20 VAC 5-302-35	Added	19:1 VA.R. 118	8/21/02
20 VAC 5-312-90	Erratum	18:23 VA.R. 3136	--
20 VAC 5-312-90	Amended	19:1 VA.R. 121	1/1/03
20 VAC 5-312-100	Amended	18:26 VA.R. 3904	1/1/03
20 VAC 5-312-120	Added	18:26 VA.R. 3905	1/1/03
20 VAC 5-423-10 through 20 VAC 5-423-90	Added	18:14 VA.R. 1899-1902	3/6/02
<b>Title 22. Social Services</b>			
22 VAC 5-10-10	Amended	19:1 VA.R. 124	10/23/02
22 VAC 5-10-20	Amended	19:1 VA.R. 124	10/23/02
22 VAC 5-10-100	Amended	19:1 VA.R. 124	10/23/02



## Cumulative Table of VAC Sections Adopted, Amended, or Repealed

SECTION NUMBER	ACTION	CITE	EFFECTIVE DATE
22 VAC 5-20-20 through 22 VAC 5-20-100	Amended	19:1 VA.R. 124-132	10/23/02
22 VAC 5-20-110	Repealed	19:1 VA.R. 132	10/23/02
22 VAC 5-20-120	Amended	19:1 VA.R. 132	10/23/02
22 VAC 5-20-140	Amended	19:1 VA.R. 133	10/23/02
22 VAC 5-20-150	Amended	19:1 VA.R. 134	10/23/02
22 VAC 5-20-170	Amended	19:1 VA.R. 134	10/23/02
22 VAC 5-20-180	Amended	19:1 VA.R. 134	10/23/02
22 VAC 5-20-190	Amended	19:1 VA.R. 134	10/23/02
22 VAC 5-20-210	Amended	19:1 VA.R. 134	10/23/02
22 VAC 5-20-230	Amended	19:1 VA.R. 134	10/23/02
22 VAC 5-20-250	Amended	19:1 VA.R. 134	10/23/02
22 VAC 5-20-300	Amended	19:1 VA.R. 134	10/23/02
22 VAC 5-20-310	Amended	19:1 VA.R. 134	10/23/02
22 VAC 5-20-330	Amended	19:1 VA.R. 134	10/23/02
22 VAC 5-20-450	Amended	19:1 VA.R. 135	10/23/02
22 VAC 5-20-460	Amended	19:1 VA.R. 135	10/23/02
22 VAC 5-20-580	Amended	19:1 VA.R. 135	10/23/02
22 VAC 5-20-600	Amended	19:1 VA.R. 136	10/23/02
22 VAC 15-10-10	Amended	18:14 VA.R. 1902	5/1/02
22 VAC 15-10-30	Amended	18:14 VA.R. 1902	5/1/02
22 VAC 15-10-40	Amended	18:14 VA.R. 1902	5/1/02
22 VAC 15-10-50	Amended	18:14 VA.R. 1902	5/1/02
22 VAC 15-10-60	Amended	18:14 VA.R. 1902	5/1/02
22 VAC 15-10-70	Amended	18:14 VA.R. 1902	5/1/02
22 VAC 15-30 (Forms)	Amended	19:4 VA.R. 695	--
22 VAC 15-60-10 through 22 VAC 15-60-180	Repealed	19:2 VA.R. 351	11/6/02
22 VAC 20-20-10 through 22 VAC 20-20-110	Amended	19:4 VA.R. 694	1/1/03
22 VAC 40-41-10	Amended	18:12 VA.R. 1696	4/1/02
22 VAC 40-41-20	Amended	18:12 VA.R. 1696	4/1/02
22 VAC 40-41-40	Amended	18:12 VA.R. 1696	4/1/02
22 VAC 40-41-50	Amended	18:12 VA.R. 1696	4/1/02
22 VAC 40-41-55	Added	18:12 VA.R. 1696	4/1/02
22 VAC 40-60 (Forms)	Amended	19:4 VA.R. 695	--
22 VAC 40-90-10	Amended	19:2 VA.R. 352	11/6/02
22 VAC 40-90-20	Amended	19:2 VA.R. 353	11/6/02
22 VAC 40-90-60	Amended	19:2 VA.R. 353	11/6/02
22 VAC 40-92-10 through 22 VAC 40-92-180	Repealed	19:3 VA.R. 531	11/20/02
22 VAC 40-685-10 emer	Added	18:24 VA.R. 3320	9/1/02-8/31/03
22 VAC 40-685-20 emer	Added	18:24 VA.R. 3321	9/1/02-8/31/03
22 VAC 40-685-30 emer	Added	18:24 VA.R. 3321	9/1/02-8/31/03
22 VAC 40-690 (Forms)	Amended	18:22 VA.R. 2945	--
22 VAC 40-720-10	Amended	19:3 VA.R. 531	11/20/02
22 VAC 40-730-10	Amended	19:3 VA.R. 532	11/20/02
22 VAC 40-730-20	Amended	19:3 VA.R. 533	11/20/02
22 VAC 40-730-40 through 22 VAC 40-730-90	Amended	19:3 VA.R. 533	11/20/02
22 VAC 40-880-10	Amended	18:14 VA.R. 1903	4/24/02
22 VAC 40-880-30	Amended	18:14 VA.R. 1903	4/24/02
22 VAC 40-880-60	Amended	18:14 VA.R. 1903	4/24/02
22 VAC 40-880-80	Amended	18:14 VA.R. 1903	4/24/02
22 VAC 40-880-110	Amended	18:14 VA.R. 1903	4/24/02
22 VAC 40-880-120	Amended	18:14 VA.R. 1903	4/24/02
22 VAC 40-880-130	Amended	18:14 VA.R. 1903	4/24/02
22 VAC 40-880-170	Amended	18:14 VA.R. 1903	4/24/02
22 VAC 40-880-190	Amended	18:14 VA.R. 1903	4/24/02
22 VAC 40-880-200 through 22 VAC 40-880-300	Amended	18:14 VA.R. 1903	4/24/02
22 VAC 40-880-270	Erratum	18:17 VA.R. 2183	--

---

## Cumulative Table of VAC Sections Adopted, Amended, or Repealed

---

SECTION NUMBER	ACTION	CITE	EFFECTIVE DATE
22 VAC 40-880-290	Erratum	18:17 VA.R. 2183	--
22 VAC 40-880-320	Amended	18:14 VA.R. 1903	4/24/02
22 VAC 40-880-330	Amended	18:14 VA.R. 1903	4/24/02
22 VAC 40-880-340	Amended	18:14 VA.R. 1903	4/24/02
22 VAC 40-880-360	Amended	18:14 VA.R. 1903	4/24/02
22 VAC 40-880-380	Amended	18:14 VA.R. 1903	4/24/02
22 VAC 40-880-385	Added	18:14 VA.R. 1903	4/24/02
22 VAC 40-880-410	Amended	18:14 VA.R. 1903	4/24/02
22 VAC 40-880-430	Amended	18:14 VA.R. 1903	4/24/02
22 VAC 40-880-440	Amended	18:14 VA.R. 1903	4/24/02
22 VAC 40-880-480 through 22 VAC 40-880-520	Amended	18:14 VA.R. 1903	4/24/02
22 VAC 40-880-550	Amended	18:14 VA.R. 1903	4/24/02
22 VAC 40-880-560	Amended	18:14 VA.R. 1903	4/24/02
22 VAC 40-880-650	Amended	18:14 VA.R. 1903	4/24/02
22 VAC 40-880-670	Amended	18:14 VA.R. 1903	4/24/02
22 VAC 40-880-680	Amended	18:14 VA.R. 1903	4/24/02
22 VAC 40-880-700	Amended	18:14 VA.R. 1903	4/24/02
22 VAC 40-880-720	Added	18:14 VA.R. 1903	4/24/02
22 VAC 40-910-10 through 22 VAC 40-910-100 emer	Added	18:24 VA.R. 3322-3325	9/1/02-8/31/03
<b>Title 24. Transportation and Motor Vehicles</b>			
24 VAC 15-100	Repealed	18:22 VA.R. 2933	6/26/02
24 VAC 15-110	Repealed	18:22 VA.R. 2933	6/26/02
24 VAC 15-120	Repealed	18:22 VA.R. 2933	6/26/02
24 VAC 15-130	Repealed	18:22 VA.R. 2933	6/26/02
24 VAC 15-140	Repealed	18:22 VA.R. 2933	6/26/02
24 VAC 15-150	Repealed	18:22 VA.R. 2933	6/26/02
24 VAC 15-160	Repealed	18:22 VA.R. 2933	6/26/02
24 VAC 15-170	Repealed	18:22 VA.R. 2933	6/26/02
24 VAC 15-180	Repealed	18:22 VA.R. 2933	6/26/02
24 VAC 15-190	Repealed	18:22 VA.R. 2933	6/26/02
24 VAC 15-200	Repealed	18:22 VA.R. 2933	6/26/02
24 VAC 15-210	Repealed	18:22 VA.R. 2933	6/26/02
24 VAC 30-270	Repealed	19:3 VA.R. 533	9/18/02
24 VAC 30-271-10	Added	19:3 VA.R. 533	9/18/02
24 VAC 30-271-20	Added	19:3 VA.R. 533	9/18/02
24 VAC 30-550-10	Amended	18:23 VA.R. 3100	7/2/02

---

# PETITIONS FOR RULEMAKING

---

## DEPARTMENT OF CONSERVATION AND RECREATION

### Initial Agency Notice

Title of Regulation: **4 VAC 5-30. Virginia State Parks Regulations.**

Statutory Authority: § 10.1-104 of the Code of Virginia.

Name of Petitioner: Matt Chancey.

Nature of Request: The petitioner is requesting the Department of Conservation and Recreation to amend 4 VAC 5-30-200 to allow individuals to carry a holstered firearm openly.

(Note: The department has already been directed by the Governor to initiate a separate regulatory action to amend 4 VAC 5-30-200 to allow the carrying of concealed handguns within state parks by holders of a valid Concealed Handgun Permit issued pursuant to § 18.2-308 of the Code of Virginia.)

Agency's Plan for Disposition of Request:

NOTE: All written comments submitted must reference the specific petition to which they are responding. This petition is the "Chancey Petition - A."

Written comments may be sent to the Regulatory Coordinator at: Virginia Department of Conservation and Recreation, 203 Governor Street, Suite 302, Richmond, Virginia 23219.

Comments may be e-mailed to the Regulatory Coordinator at: [regcord@dcr.state.va.us](mailto:regcord@dcr.state.va.us).

Comments may be faxed to the Regulatory Coordinator at: (804) 786-6141.

The agency shall issue a written decision to grant or deny the petitioner's request within 90 days (March 8, 2003) following the close of the comment period.

Public comments may be submitted until December 9, 2002, at 5 p.m.

Agency Contact: Leon E. App, Acting Deputy Director, Virginia Department of Conservation and Recreation, 203 Governor Street, Suite 302, Richmond, Virginia 23219, telephone (804) 786-6124, FAX (804) 786-6141 or e-mail [regcord@dcr.state.va.us](mailto:regcord@dcr.state.va.us)

VA.R. Doc. No. R03-55; Filed October 16, 2002, 1:44 p.m.

### Initial Agency Notice

Title of Regulation: **4 VAC 5-30. Virginia State Parks Regulations.**

Statutory Authority: § 10.1-104 of the Code of Virginia.

Name of Petitioner: Mike McHugh, President, Virginia Gun Owners Coalition.

Nature of Request: The petitioner is requesting the Department of Conservation and Recreation to repeal 4 VAC

5-30-200, thus allowing open carry unless otherwise restricted by law.

(Note: The department has already been directed by the Governor to initiate a separate regulatory action to amend 4 VAC 5-30-200 to allow the carrying of concealed handguns within state parks by holders of a valid Concealed Handgun Permit issued pursuant to § 18.2-308 of the Code of Virginia.)

Agency's Plan for Disposition of Request:

NOTE: All written comments submitted must reference the specific petition to which they are responding. This petition is the "McHugh Petition - A."

Written comments may be sent to the Regulatory Coordinator at: Virginia Department of Conservation and Recreation, 203 Governor Street, Suite 302, Richmond, Virginia 23219.

Comments may be e-mailed to the Regulatory Coordinator at: [regcord@dcr.state.va.us](mailto:regcord@dcr.state.va.us).

Comments may be faxed to the Regulatory Coordinator at: (804) 786-6141.

The agency shall issue a written decision to grant or deny the petitioner's request within 90 days (March 8, 2003) following the close of the comment period.

Public comments may be submitted until December 9, 2002, at 5 p.m.

Agency Contact: Leon E. App, Acting Deputy Director, Virginia Department of Conservation and Recreation, 203 Governor Street, Suite 302, Richmond, Virginia 23219, telephone (804) 786-6124, FAX (804) 786-6141 or e-mail [regcord@dcr.state.va.us](mailto:regcord@dcr.state.va.us)

VA.R. Doc. No. R03-58; Filed October 23, 2002, 9:52 a.m.

---

# NOTICES OF INTENDED REGULATORY ACTION

---

## Symbol Key

† Indicates entries since last publication of the *Virginia Register*

---

## TITLE 6. CRIMINAL JUSTICE AND CORRECTIONS

### STATE BOARD OF JUVENILE JUSTICE

#### Notice of Intended Regulatory Action

Notice is hereby given in accordance with § 2.2-4007 of the Code of Virginia that the State Board of Juvenile Justice intends to consider amending regulations entitled: **6 VAC 35-30. Regulations for State Reimbursement of Local Juvenile Residential Facility Costs.** The purpose of the proposed action is to establish the process for evaluating requests from localities for state reimbursement of local juvenile residential facility construction costs, including criteria to assess need and establish priorities for construction projects, and a methodology for determining appropriate costs.

The agency intends to hold a public hearing on the proposed action after publication in the Virginia Register.

Statutory Authority: §§ 16.1-309.5 and 66-10 of the Code of Virginia.

Public comments may be submitted until December 13, 2002.

**Contact:** Donald R. Carignan, Regulatory Coordinator, Department of Juvenile Justice, 700 Centre, 700 E. Franklin St., Richmond, VA 23219, telephone (804) 371-0743 or FAX (804) 371-0773 or e-mail carigndr@djj.state.va.us.

VA.R. Doc. No. R03-50; Filed October 3, 2002, 11:26 a.m.

---

## TITLE 12. HEALTH

### STATE BOARD OF HEALTH

#### Notice of Intended Regulatory Action

Notice is hereby given in accordance with § 2.2-4007 of the Code of Virginia that the State Board of Health intends to consider repealing regulations entitled: **12 VAC 5-500. Rules and Regulations Governing the Construction and Maintenance of Migrant Labor Camps** and promulgating regulations entitled: **12 VAC 5-501. Rules and Regulations Governing the Construction and Maintenance of Migrant Labor Camps.** The purpose of the proposed action is to comprehensively update the current regulations. Due to the nature and extent of the changes and the desire to reorganize all the department's environmental regulations along a customer-friendly and familiar structure, the existing migrant labor camp regulations will be repealed and a new set of regulations adopted. Key changes being considered include (i)

eliminating the requirement for all migrant labor camps that provide water via their own well to construct the well in accordance with the Virginia Waterworks Regulations; (ii) eliminating provisional permits; and (iii) removing the biweekly inspection requirement. All other changes are for clarity and uniformity.

The agency intends to hold a public hearing on the proposed action after publication in the Virginia Register.

Statutory Authority: § 32.1-211 of the Code of Virginia.

Public comments may be submitted until November 22, 2002.

**Contact:** Gary L. Hagy, Director, Division of Food and Environmental Services, P.O. Box 2448, Room 115, Richmond, VA 23218-2448, telephone (804) 225-4022, FAX (804) 225-4003 or e-mail ghagy@vdh.state.va.us.

VA.R. Doc. No. R03-37; Filed September 24, 2002, 10:29 a.m.

#### Notice of Intended Regulatory Action

Notice is hereby given in accordance with § 2.2-4007 of the Code of Virginia that the State Board of Health intends to consider amending regulations entitled: **12 VAC 5-585. Biosolids Use Regulations.** The purpose of the proposed action is to address certain issues raised by local governments including (i) posting of informational signs at permitted sites prior to and during land application of biosolids; (ii) evidence of financial responsibility (such as liability insurance or other financial resources) in a determined amount, resulting from the land application of biosolids; (iii) notification of local governments prior to the land application of biosolids at specific sites; (iv) development and implementation of spill prevention and response plans by permitted entities; and (v) methods for communicating information on complaints and reported incidents related to or arising from the land application of biosolids.

The agency does not intend to hold a public hearing on the proposed action after publication in the Virginia Register.

Statutory Authority: § 32.1-164 of the Code of Virginia.

Public comments may be submitted until 5 p.m., December 6, 2002.

**Contact:** Cal Sawyer, Director, Division of Wastewater Engineering, Department of Health, 1500 E. Main St., Suite 109, Richmond, VA 23219, telephone (804) 786-1755, FAX (804) 786-5566 or e-mail csawyer@vdh.state.va.us.

VA.R. Doc. No. R03-57; Filed October 16, 2002, 10:51 a.m.

## DEPARTMENT OF MEDICAL ASSISTANCE SERVICES

### Notice of Intended Regulatory Action

Notice is hereby given in accordance with § 2.2-4007 of the Code of Virginia that the Department of Medical Assistance Services intends to consider amending regulations entitled: **12 VAC 30-80. Methods and Standards for Establishing Payment Rates; Other Types of Care: Pharmacy Services.** The purpose of the proposed action is to conform the DMAS definition of unit dose to the definition used by the Board of Pharmacy and to change the reimbursement rate for the service of unit dose dispensing to a per capita monthly fee.

The agency does not intend to hold a public hearing on the proposed action after publication in the Virginia Register.

Statutory Authority: §§ 32.1-324 and 32.1-325 of the Code of Virginia.

Public comments may be submitted until December 4, 2002, to Alissa Nashwinter, Division of Program Operations, Department of Medical Assistance Services, 600 East Broad Street, Suite 1300, Richmond, VA 23219.

**Contact:** Victoria P. Simmons, Regulatory Coordinator, Department of Medical Assistance Services, 600 E. Broad St., Suite 1300, Richmond, VA 23219, telephone (804) 786-7959, FAX (804) 786-1680 or e-mail vsimmons@dmas.state.va.us.

VA.R. Doc. No. R03-51; Filed October 10, 2002, 8:41 a.m.

### Notice of Intended Regulatory Action

Notice is hereby given in accordance with § 2.2-4007 of the Code of Virginia that the Department of Medical Assistance Services intends to consider amending regulations entitled: **12 VAC 30-120. Waiver Services.** The purpose of the proposed action is to expand the existing waiver program to provide for the automatic transfer of children who do not have a diagnosis of mental retardation from the mental retardation waiver program to the individual and family developmental disabilities support (IFDDS) waiver program once they attain their sixth birthday.

The agency does not intend to hold a public hearing on the proposed action after publication in the Virginia Register.

Statutory Authority: §§ 32.1-324 and 32.1-325 of the Code of Virginia.

Public comments may be submitted until November 20, 2002.

**Contact:** Sherry Confer, Policy Analyst, Division of LTC, Department of Medical Assistance Services, 600 E. Broad St., Suite 1300, Richmond, VA 23219, telephone (804) 371-6995, FAX (804) 786-1680 or e-mail sconfer@dmas.state.va.us.

VA.R. Doc. No. R03-35; Filed September 23, 2002, 4:48 p.m.

## TITLE 18. PROFESSIONAL AND OCCUPATIONAL LICENSING

### BOARD OF ACCOUNTANCY

### † Notice of Intended Regulatory Action

Notice is hereby given in accordance with § 2.2-4007 of the Code of Virginia that the Board of Accountancy intends to consider amending regulations entitled: **18 VAC 5-21. Board of Accountancy Rules and Regulations.** The purpose of the proposed action is to revise and clarify the following sections: (i) definitions; (ii) fees; (iii) qualifications for licensure (includes clarified language about the current CPA exam, and new language about the forthcoming computer-based CPA exam); (iv) issuance of a license to initial applicants, through endorsement, and by substantial equivalency; (v) registration of CPA firms (includes clarified language about the peer review requirements); (vi) standards of conduct and practice; and (vii) continuing professional education requirements for initial applicants, license holders and non-CPA owners. The board may propose new provisions governing: (i) the practice of CPAs in the Commonwealth who have not been issued a Virginia CPA license; (ii) the requirements for non-CPA owners in CPA firms; and (iii) enforcement actions against regulants.

The agency intends to hold a public hearing on the proposed action after publication in the Virginia Register.

Statutory Authority: §§ 54.1-4402 and 54.1-4403 of the Code of Virginia.

Public comments may be submitted until December 18, 2002.

**Contact:** Nancy Taylor Feldman, Executive Director, Board of Accountancy, 3600 W. Broad St., Suite 696, Richmond, VA 23230-4916, telephone (804) 367-8505 or FAX (804) 367-2174.

VA.R. Doc. No. R03-64; Filed October 30, 2002, 10:55 a.m.

---

## TITLE 22. SOCIAL SERVICES

### DEPARTMENT OF REHABILITATIVE SERVICES

### Notice of Intended Regulatory Action

Notice is hereby given in accordance with § 2.2-4007 of the Code of Virginia that the Department of Rehabilitative Services intends to consider amending regulations entitled: **22 VAC 30-30. Provision of Independent Living Services.** The purpose of the proposed action is to update the regulations to be consistent with federal regulations, exempt additional consumer groups from the requirement to pay for services and expand the list of services provided at no cost to clients.

The agency does not intend to hold a public hearing on the proposed action after publication in the Virginia Register.

---

# Notices of Intended Regulatory Action

---

Statutory Authority: § 51.5-14 of the Code of Virginia.

Public comments may be submitted until November 21, 2002, to Elizabeth E. Smith, Policy and Planning Director, Department of Rehabilitative Services, 8004 Franklin Farms Drive., P.O. Box K-300, Richmond, VA 23288-0300.

**Contact:** Theresa Preda, Program Manager, Independent Living, Department of Rehabilitative Services, 8004 Franklin Farms Dr., P.O. Box K-300, Richmond, VA 23288-0300, telephone (804) 662-7078, FAX (804) 662-7122, toll-free 1-800-552-5019 or e-mail [predaTR@dss.state.va.us](mailto:predaTR@dss.state.va.us).

VA.R. Doc. No. R03-36; Filed September 23, 2002, 4:04 p.m.

## STATE BOARD OF SOCIAL SERVICES

### Notice of Intended Regulatory Action

Notice is hereby given in accordance with § 2.2-4007 of the Code of Virginia that the State Board of Social Services intends to consider amending regulations entitled: **22 VAC 40-80. General Procedures and Information for Licensure**. The purpose of the proposed action is to amend the regulation to clarify and simplify some standards and to incorporate changes that have been made to the Code of Virginia since the last revision of this regulation. Many changes are the result of the recodification of Title 63.1 of the Code of Virginia that became effective October 1, 2002. The Code of Virginia mandates that the Department of Social Services license certain facilities that provide care to children and adults. Programmatic regulations are developed for these facilities. The current regulation contains general licensing requirements that are applicable to all licensed programs but are not included in the programmatic regulations. Previously, this regulation was promulgated jointly by the State Board of Social Services and the Child Day-Care Council for all of the department's licensed programs. However, the Child Day-Care Council desires to promulgate a separate regulation that applies only to child day centers (the only program for which they have regulatory responsibility). This regulation will continue to contain references to child day centers, however, because of the board's sole authority to regulate some procedures and activities that are applicable to child day centers. The goal of the amended regulation is to provide clear and concise information and requirements for applicants, licensees, and licensing staff regarding the licensing process.

The agency does not intend to hold a public hearing on the proposed action after publication in the Virginia Register.

Statutory Authority: §§ 63.2-217 and 63.2-1734 of the Code of Virginia.

Public comments may be submitted until November 20, 2002.

**Contact:** Kathryn Thomas, Program Development Consultant, Department of Social Services, Department of Social Services, 730 E. Broad St., Richmond, VA 23219, telephone (804) 692-1793, FAX (804) 692-2370 or e-mail [kjt7@dss.state.va.us](mailto:kjt7@dss.state.va.us).

VA.R. Doc. No. R03-41; Filed September 30, 2002, 2:23 p.m.

### Notice of Intended Regulatory Action

Notice is hereby given in accordance with § 2.2-4007 of the Code of Virginia that the State Board of Social Services intends to consider amending regulations entitled: **22 VAC 40-141. Minimum Standards for Licensed Independent Foster Homes**. The purpose of the proposed action is to amend existing standards for licensed independent foster homes to clarify the intent of the regulation and to incorporate changes made in the Code of Virginia as a result of the recodification of Title 63.1, effective October 1, 2002. Proposed amendments include allowing placement agreements thereby allowing parental retention of custody; allowing children to remain in the independent foster home no longer than six months in certain circumstances; updating medical requirements; clarifying capacity; revising standards regarding physical restraint and time-out/separation; strengthening requirements surrounding care of infants; updating safety requirements; clarifying exceptions; and including language regarding respecting diversity and the responsibilities of the licensee.

The agency does not intend to hold a public hearing on the proposed action after publication in the Virginia Register.

Statutory Authority: §§ 63.2-217 and 63.2-1734 of the Code of Virginia.

Public comments may be submitted until November 20, 2002.

**Contact:** Cynthia Carneal, Operations Consultant, Department of Social Services, 730 E. Broad St., Richmond, VA 23219, telephone (804) 692-2421, FAX (804) 692-2370, or e-mail [cyc900@dss.state.va.us](mailto:cyc900@dss.state.va.us).

VA.R. Doc. No. R03-42; Filed September 30, 2002, 2:24 p.m.

### Notice of Intended Regulatory Action

Notice is hereby given in accordance with § 2.2-4007 of the Code of Virginia that the State Board of Social Services intends to consider repealing regulations entitled: **22 VAC 40-190. Regulation for Criminal Record Checks for Child Welfare Agencies** and adopting regulations entitled: **22 VAC 40-191. Background Checks for Child Welfare Agencies**. The purpose of the proposed action is to repeal the regulation, Regulation for Criminal Records Checks for Child Welfare Agencies, in order to promulgate a new regulation, Background Checks for Child Welfare Agencies. The new regulation establishes background checks for child welfare agencies and is needed to reflect changes to the Code of Virginia from 1995 to the present.

The agency does not intend to hold a public hearing on the proposed action after publication in the Virginia Register.

Statutory Authority: § 63.2-1704 of the Code of Virginia.

Public comments may be submitted until November 20, 2002.

**Contact:** Wenda Singer, Program Consultant, Department of Social Services, 730 E Broad St., Richmond, VA 23219, telephone (804) 692-2201, FAX (804) 692-2370 or e-mail [wxs2@dss.state.va.us](mailto:wxs2@dss.state.va.us).

VA.R. Doc. Nos. R03-43 and R03-44; Filed September 30, 2002, 2:23 p.m.

### † **Withdrawal of Notice of Intended Regulatory Action**

Notice is hereby given that the State Board of Social Services has WITHDRAWN the Notice of Intended Regulatory Action for **22 VAC 40-770, Standards and Regulations for Agency Approved Providers**, which was published in 15:22 VA.R. 2768 July 19, 1999. This action was taken at the board's October 16, 2002, meeting.

**Contact:** Richard Martin, Regulatory Coordinator, Department of Social Services, 730 E. Broad St., Richmond, VA 23219, telephone (804) 692-1825.

VA.R. Doc. No. R99-201; Filed October 22, 2002, 2:10 p.m.



# PROPOSED REGULATIONS

For information concerning Proposed Regulations, see Information Page.

## Symbol Key

Roman type indicates existing text of regulations. *Italic type* indicates proposed new text.  
Language which has been stricken indicates proposed text for deletion.

## TITLE 4. CONSERVATION AND NATURAL RESOURCES

### BOARD OF GAME AND INLAND FISHERIES

**REGISTRAR'S NOTICE:** The Board of Game and Inland Fisheries is exempt from the Administrative Process Act pursuant to subdivision A 3 of § 2.2-4002 of the Code of Virginia when promulgating regulations regarding the management of wildlife. The department is required by § 2.2-4031 of the Code of Virginia to publish all proposed and final wildlife management regulations, including length of seasons and bag limits allowed on the wildlife resources within the Commonwealth of Virginia.

**Title of Regulation:** 4 VAC 15-30. Definitions and Miscellaneous: Importation, Possession, Sale, Etc., of Animals (amending 4 VAC 15-30-40).

**Statutory Authority:** §§ 29.1-501 and 29.1-502 of the Code of Virginia.

**NOTICE TO THE PUBLIC:** The Board of Game and Inland Fisheries has ordered to be published, pursuant to §§ 29.1-501 and 29.1-502 of the Code of Virginia, the following proposed amendment to board regulations. A public comment period on the proposed regulation opened October 24, 2002, and remains open until November 23, 2002. Comments submitted must be in writing; must be accompanied by the name, address and telephone number of the party offering the comments; should state the regulatory action desired; and should state the justification for the desired action. Comments should be sent to Phil Smith, Policy Analyst and Regulatory Coordinator, Department of Game and Inland Fisheries, 4010 West Broad Street, Richmond, Virginia 23230.

If the director is satisfied that the proposed regulation, or any parts thereof, is advisable, in the form in which published or as amended after receipt of the public's comments, under the authority delegated by the board the director may adopt regulation amendments as final on or after November 24, 2002. The regulation or regulation amendment adopted may be either more liberal or more restrictive than that proposed and being advertised under this notice.

**Agency Contact:** Phil Smith, Policy Analyst and Regulatory Coordinator, 4010 West Broad Street, Richmond, VA 23230, telephone (804) 367-1000, FAX (804) 367-0488 or e-mail regcomments@dgif.state.va.us.

#### Summary:

*The proposed amendments remove deer, elk, and all other members of the deer family (Cervidae) from the exception that allows certain nonnative mammals to be imported into the Commonwealth under license or registration from the U.S. Department of Agriculture without a Virginia DGIF permit.*

#### 4 VAC 15-30-40. Importation requirements, possession and sale of nonnative (exotic) animals.

A. Permit required. A special permit is required and may be issued by the department, if consistent with the department's fish and wildlife management program, to import, possess, or sell those nonnative (exotic) animals listed below that the board finds and declares to be predatory or undesirable within the meaning and intent of § 29.1-542 of the Code of Virginia, in that their introduction into the Commonwealth will be detrimental to the native fish and wildlife resources of Virginia:

#### AMPHIBIANS:

Order	Family	Genus/Species	Common Name
Anura	Bufo	Bufo marinus	Giant or marine toad*
	Pipidae	Xenopus spp.	Tongueless or African clawed frog
Caudata	Ambystomatidae	Ambystoma tigrinum mavortium	Barred tiger salamander
		A. t. diaboli	Gray tiger salamander
		A. t. melanostictum	Blotched tiger salamander

#### BIRDS:

Order	Family	Genus/Species	Common Name
Psittaciformes	Psittacidae	Myiopsitta monachus	Monk parakeet*



## Proposed Regulations

### FISH:

Order	Family	Genus/Species	Common Name	
Cypriniformes	Catostomidae	Ictiobus bubalus	Smallmouth buffalo*	
		I. cyprinellus	Bigmouth buffalo*	
		I. niger	Black buffalo*	
	Characidae	Pygopristis spp. Pygocentrus spp. Rooseveltiella spp. Serrasalmo spp. Serrasalmus spp. Taddyella spp.	Piranhas	
		Cyprinidae	Aristichyhs nobilis	Bighead carp*
			Ctenopharyngodon idella	Grass carp or white amur
			Cyprinella lutrensis	Red shiner
			Hypophthalmichthys molitrix	Silver carp*
			Mylopharyngodon piceus	Black carp
	Scardinius erythrophthalmus		Rudd	
Tinca tinca	Tench*			
Gobiesociformes	Gobiidae	Proterorhinus marmoratus	Tube-nose goby	
		Neogobius melanostomus	Round goby	
Perciformes	Cichlidae	Tilapia spp.	Tilapia	
		Gymnocephalus cernuum	Ruffe*	
Siluriformes	Clariidae	All Species	Air-breathing catfish	
Synbranchiformes	Synbranchidae	Monopterus albus	Swamp eel	

### MAMMALS:

Order	Family	Genus/Species	Common Name
Artiodactyla	Suidae	All Species	Pigs or Hogs*
	Cervidae	All Species	Deer*
Carnivora	Canidae	All Species	Wild Dogs,* Wolves, Coyotes or Coyote hybrids, Jackals and Foxes
	Ursidae	All Species	Bears*
	Procyonidae	All Species	Raccoons and* Relatives
	Mustelidae	All Species	Weasels, Badgers,* Skunks and Otters
		(except Mustela putorius furo)	Ferret
	Viverridae	All Species	Civets, Genets, Lingsangs, Mongooses, and Fossas
	Herpestidae	All Species	Mongooses*
	Hyaenidae	All Species	Hyenas*
Protelidae	Proteles cristatus	Aardwolf*	
Chiroptera		All Species	Bats*
Lagomorpha	Leporidae	Lepus europeaeus	European hare
		Oryctolagus cuniculus	European rabbit
Rodentia	Sciuridae	Cynomys spp.	Prairie dogs

# Proposed Regulations

## MOLLUSKS:

Order	Family	Genus/Species	Common Name
Veneroida	Dreissenidae	Dreissena polymorpha	Zebra mussel

## REPTILES:

Order	Family	Genus/Species	Common Name
Squamata	Alligatoridae	All Species	Alligators, Caimans*
	Colubridae	Boiga irregularis	Brown tree snake*
	Crocodylidae	All Species	Crocodiles*
	Gavialidae	All Species	Gavials*

B. Temporary possession permit for certain animals. Notwithstanding the permitting requirements of subsection A, a person, company or corporation possessing any nonnative (exotic) animal, designated with an asterisk (\*) in subsection A, prior to July 1, 1992, must declare such possession in writing to the department by January 1, 1993. This written declaration shall serve as a permit for possession only, is not transferable, and must be renewed every five years. This written declaration must include species name, common name, number of individuals, date or dates acquired, sex (if possible), estimated age, height or length, and other characteristics such as bands and band numbers, tattoos, registration numbers, coloration, and specific markings. Possession transfer will require a new permit according to the requirements of this subsection.

C. Exception for certain monk parakeets. A permit is not required for monk parakeets (quakers) that have been captive bred and are closed-banded with a seamless band.

D. Exception for parts or products. A permit is not required for parts or products of those nonnative (exotic) animals listed in subsection A that may be used for personal use, in the manufacture of products, or used in scientific research, provided that such parts or products be packaged outside the Commonwealth by any person, company, or corporation duly licensed by the state in which the parts originate. Such packages may be transported into the Commonwealth, consistent with other state laws and regulations, so long as the original package remains unbroken, unopened and intact until its point of destination is reached. Documentation concerning the type and cost of the animal parts ordered, the purpose and date of the order, point and date of shipping, and date of receiving shall be kept by the person, business or institution ordering such nonnative (exotic) animal parts. Such documentation shall be open to inspection by a representative of the Department of Game and Inland Fisheries.

E. Exception for certain mammals. Nonnative (exotic) mammals listed in subsection A, *except members of the Cervidae family*, that are imported or possessed by dealers, exhibitors, transporters, and researchers who are licensed or registered by the United States Department of Agriculture under the Animal Welfare Act (7 USC §§ 2131 et seq.) will be deemed to be permitted pursuant to this section, provided that those individuals wanting to import such animals notify the

department 24 hours prior to importation with a list of animals to be imported, a schedule of dates and locations where those animals will be housed while in the Commonwealth, and a copy of the current license or licenses or registration or registrations from the U.S. Department of Agriculture, and further provided that such animals shall not be liberated within the Commonwealth.

F. Exception for prairie dogs. The effective date of listing of prairie dogs under subsection A of this section shall be January 1, 1998. Prairie dogs possessed in captivity in Virginia on December 31, 1997, may be maintained in captivity until the animals' deaths, but they may not be sold on or after January 1, 1998, without a permit.

G. All other nonnative (exotic) animals. All other nonnative (exotic) animals not listed in subsection A of this section may be possessed, purchased, and sold; provided, that such animals shall be subject to all applicable local, state, and federal laws and regulations, including those that apply to threatened/endangered species, and further provided, that such animals shall not be liberated within the Commonwealth.

VA.R. Doc. No. R03-63; Filed October 30, 2002, 11:12 a.m.



## TITLE 12. HEALTH

### STATE MENTAL HEALTH, MENTAL RETARDATION AND SUBSTANCE ABUSE SERVICES BOARD

**Title of Regulation:** 12 VAC 35-11. Public Participation Guidelines (amending 12 VAC 35-11-10 through 12 VAC 35-11-90; adding 12 VAC 35-11-15 and 12 VAC 35-11-110; repealing 12 VAC 35-11-100).

**Statutory Authority:** § 2.2-4007 and 37.1-10 of the Code of Virginia.

**Public Hearing Date:** N/A -- Public comments may be submitted until January 17, 2003.

(See Calendar of Events section for additional information)

**Agency Contact:** Wendy V. Brown, Policy Analyst, Department of Mental Health, Mental Retardation and Substance Abuse

Services, P.O. Box 1797, Richmond, VA 23218-1797, telephone (804) 225-2252, FAX (804) 371-0092 or e-mail [wbrown@dmhmrsas.state.va.us](mailto:wbrown@dmhmrsas.state.va.us).

**Basis:** Section 37.1-10 of the Code of Virginia authorizes the Board of Mental Health, Mental Retardation and Substance Abuse Services (board) to promulgate rules and regulations that are necessary to carry out provisions of the law. Section 2.2-4007 of the Code of Virginia requires the board to promulgate public participation guidelines for soliciting the input of interested parties in the formation and development of its regulations.

**Purpose:** The general goal of the regulation is to articulate procedures to promote the participation of citizens in the regulatory actions undertaken by the board. This regulation is an important tool to ensure that the public has the means to participate in the development of regulations. The existing Public Participation Guidelines were promulgated in 1995 and are now somewhat outdated. The amendment updates the regulation by including provisions for the use of electronic technology to facilitate public participation in the regulatory process. It also adds provisions for periodic review, which will require the board to review and receive public comment on all of its regulations on a routine basis to determine their effectiveness in achieving their goals. These updates should help ensure that the views of the public are reflected in regulations and that the regulations are designed to include essential protections for the health, safety and welfare of citizens.

In addition, the existing regulation consistently refers to the Department of Mental Health, Mental Retardation and Substance Abuse Services as the entity responsible for promulgation of regulations. This is not consistent with the Code of Virginia, which conveys authority for promulgation of regulations on the board. The amendment clarifies that the board, rather than the department, has this legal authority for rulemaking.

**Substance:** The amendment includes a new "Definitions" section in Part I that defines the important terms used in the regulation. This should help to clarify the regulation.

Part II of the regulation has been changed from "Mailing" list to "Notification" list and includes provisions for communication between the agency and the public either electronically or in writing. It also requires that notice of comment periods and proposed regulations be posted electronically. These provisions are intended to update the regulations and facilitate public involvement in the regulatory process.

A new Part V, "Periodic Review of Regulations," has been added to require the board to review and receive public comment on all of its regulations on a routine basis to determine whether these regulations are effective in meeting their specific goals.

**Issues:** The proposed amendments should be advantageous to private citizens and groups with an interest in issues relative to mental health, mental retardation and substance abuse services in Virginia. The updates to the regulation should improve the ability of citizens and groups to communicate with the board during the regulatory process and help to ensure that the board considers all relevant issues

and concerns when it develops regulations. By expanding the opportunities for such communication, the board should maximize its ability to consider public input and develop regulations that are responsive to the needs of Virginia citizens.

The proposed amendment should improve the public's access to the regulatory process and should have no disadvantages to the public or the Commonwealth.

**Fiscal Impact:** There is no additional cost to the public or the Commonwealth to implement the amended regulation. The agency and the Commonwealth currently have the technological resources in place to exchange information through electronic means. Implementation of the amendment should not require any additional staff resources or training. Staff members are currently performing functions required by the amended provisions, including posting regulations and related documentation electronically on the Virginia Regulatory Townhall and the department's website, and communicating via e-mail with members of the public.

The amended regulation will not directly affect or have an impact on the cost to localities.

The regulation should make it easier for members of the public who wish to participate in the development and review of the agency's regulations. By providing for communication by electronic means, the regulation may help defray some of the participation expense.

There should be no additional cost to such individuals associated with such participation.

**Department of Planning and Budget's Economic Impact Analysis:** The Department of Planning and Budget (DPB) has analyzed the economic impact of this proposed regulation in accordance with § 2.2-4007 H of the Administrative Process Act and Executive Order Number 21 (02). Section 2.2-4007 H requires that such economic impact analyses include, but need not be limited to, the projected number of businesses or other entities to whom the regulation would apply, the identity of any localities and types of businesses or other entities particularly affected, the projected number of persons and employment positions to be affected, the projected costs to affected businesses or entities to implement or comply with the regulation, and the impact on the use and value of private property. The analysis presented below represents DPB's best estimate of these economic impacts.

Summary of the proposed regulation. The Board of Mental Health, Mental Retardation and Substance Abuse Services proposes to revise its public participation guidelines (PPGs) to clarify that the board rather than the department has the legal authority to promulgate regulations. In addition, the proposed regulation includes provisions for periodic review of regulations, eliminates unnecessary restrictions on the appointment and dissolution of ad hoc advisory committees, and incorporates electronic forms of regulatory submission, notification, and communication. Several editorial changes are also proposed.

Estimated economic impact. Under the Administrative Process Act, all state agencies that promulgate regulations are required to maintain public participation mailing lists

---

# Proposed Regulations

---

containing the names of all parties that have registered an interest in a particular regulation. Membership on these lists typically includes members of the regulated community, public interest groups, law firms, and individual citizens with an interest in a particular area of regulation.

There are no clear disadvantages associated with the changes proposed by the Board of Mental Health, Mental Retardation and Substance Abuse Services. The board will have more flexibility in establishing ad hoc advisory committees and using them as long as they are needed. Interested parties will be encouraged to be notified of regulatory actions electronically through the Virginia Regulatory Town Hall. However, individuals may also choose to remain on the traditional mailing lists, which will continue to be maintained by the board. While it is not known if this change will increase or decrease public participation in the development of the board's regulations, any change is likely to be very small.

If electronic notification and comment becomes more prevalent, there would be a reduction in printing and mailing costs incurred by the board. In addition to the potential fiscal benefits, these changes also allow the board to increase the speed of notification and the amount of information readily available to interested parties, which will increase efficiency and may enhance public participation.

Businesses and entities affected. This change will affect individuals and organizations interested in the regulations promulgated by the Board of Mental Health, Mental Retardation and Substance Abuse Services in Virginia. There are currently about 130 persons/entities, including the 15 state mental health and mental retardation facilities and the 40 community services boards, listed on the PPG mailing list for the Board of Mental Health, Mental Retardation and Substance Abuse Services.<sup>1</sup>

Localities particularly affected. No localities are particularly affected by the proposed changes to this regulation.

Projected impact on employment. The proposed changes to this regulation are not anticipated to have a significant effect on employment in Virginia.

Effects on the use and value of private property. The proposed changes to this regulation are not anticipated to have a significant effect on the use and value of private property.

Agency's Response to the Department of Planning and Budget's Economic Impact Analysis: The agency concurs with the economic impact analysis prepared by the Department of Planning and Budget.

## Summary:

*The proposed amendments clarify that the board rather than the department has the legal authority to promulgate regulations and include new provisions for periodic review of regulations. Additionally, the proposed provisions*

---

<sup>1</sup> Numbers provided by the Department of Mental Health, Mental Retardation, and Substance Abuse Services, 8/12/02.

*incorporate the use of electronic technology to facilitate public participation in the rulemaking process.*

## PART I. STATEMENT OF PURPOSE GENERAL PROVISIONS.

### 12 VAC 35-11-10. Purpose.

The purpose of this chapter is to provide guidelines for the involvement of the public in the development and promulgation of regulations of the ~~Department of State~~ Mental Health, Mental Retardation and Substance Abuse Services Board. The guidelines do not apply to regulations exempted or excluded from the provisions of the Administrative Process Act (§ ~~9-6-14:4.1~~ 2.2-4007 of the Code of Virginia).

### 12 VAC 35-11-15. Definitions.

*The following words and terms when used in this chapter shall have the following meanings unless the context clearly indicates otherwise:*

*"Board" means the State Mental Health, Mental Retardation and Substance Abuse Services Board.*

*"Department" means the Department of Mental Health, Mental Retardation and Substance Abuse Services.*

*"Notification lists" means lists used by the board to notify persons or entities pursuant to these regulations. Such lists may include lists maintained electronically through a state website (e.g., Virginia Regulatory Townhall) or by any other means.*

*"Virginia Regulatory Townhall" means the state website that is accessible to the public and used to document regulatory changes and solicit public participation in the regulatory development process. The website address for the Virginia Regulatory Townhall is <http://www.townhall.state.va.us>.*

## PART II. ~~MAILING~~ NOTIFICATION LIST.

### 12 VAC 35-11-20. Composition of the ~~mailing~~ list notification lists.

A. The ~~Department of Mental Health, Mental Retardation and Substance Abuse Services board~~ shall maintain a list notification lists of persons or entities who have requested to be notified of the formation and promulgation of regulations.

B. Any person or entity may request to be placed on the mailing notification list by indicating so *electronically* or in writing to the ~~Department of Mental Health, Mental Retardation and Substance Abuse Services board~~. The ~~Department of Mental Health, Mental Retardation and Substance Abuse Services board~~ may add to the list any person or entity it believes will serve the purpose of enhancing participation in the regulatory process.

C. The ~~Department of Mental Health, Mental Retardation and Substance Abuse Services board~~ may maintain additional mailing notification lists for persons or entities who have requested to be informed of specific regulatory issues, proposals, or actions.

D. The ~~Department of Mental Health, Mental Retardation and Substance Abuse Services board~~ shall periodically request

those on the ~~mailing list~~ *notification lists* to indicate their desire to continue to receive documents or be deleted from the list. *Persons or entities on a notification list may request that notices be sent electronically.* When mail is returned as undeliverable, ~~individuals or organizations~~ *such persons or entities* shall be deleted from the list.

## **12 VAC 35-11-30. Documents to be sent to persons or entities on the mailing list notification lists.**

Persons or entities on the ~~mailing list~~ *notification lists* described in 12 VAC 35-11-20 shall be mailed the following documents related to the promulgation of regulations:

1. A Notice of Intended Regulatory Action.
2. A Notice of Comment Period *on a proposed regulation and instructions on how to obtain a copy of the regulation.*
3. A ~~copy of any final regulation adopted by the Department of Mental Health, Mental Retardation and Substance Abuse Services~~ *notice that the board has adopted a final regulation and instructions on how to obtain a copy of the regulation.*
4. A notice of soliciting comment on a final regulation when the regulatory process has been extended.

## **12 VAC 35-11-40. Petition for rulemaking.**

A. As provided in ~~§ 9-6.14:7.4~~ *2.2-4007* of the Code of Virginia, any person may petition the ~~Department of Mental Health, Mental Retardation and Substance Abuse Services board~~ to develop a new regulation or amend an existing regulation.

B. A petition shall include but need not be limited to the following:

1. The petitioner's name, mailing address, telephone number, and, if applicable, the organization represented in the petition.
2. The number and title of the regulation to be addressed.
3. A description of the regulatory problem or need to be addressed.
4. A recommended addition, deletion, or amendment to the regulation.

C. The ~~Department of Mental Health, Mental Retardation and Substance Abuse Services board~~ shall receive, consider and respond to a petition within 180 days.

D. Nothing herein shall prohibit the ~~Department of Mental Health, Mental Retardation and Substance Abuse Services board~~ from receiving information from the public and proceeding on its own motion for rulemaking.

## **12 VAC 35-11-50. Notice of Intended Regulatory Action.**

A. The Notice of Intended Regulatory Action (*NOIRA*) shall state the purpose of the action and a brief statement of the need or problem the proposed action will address.

B. The ~~Notice of Intended Regulatory Action~~ *NOIRA* shall indicate whether the ~~Department of Mental Health, Mental Retardation and Substance Abuse Services board~~ intends to hold a public hearing on the proposed regulation after it is

published. If the ~~Department of Mental Health, Mental Retardation and Substance Abuse Services board~~ does not intend to hold a public hearing, it shall state the reason in the ~~Notice of Intended Regulatory Action~~ *NOIRA*.

C. ~~The Notice of Intended Regulatory Action shall state that a public hearing will be scheduled, if, during the 30-day comment period, the Department of Mental Health, Mental Retardation and Substance Abuse Services receives requests for a hearing from at least 25 persons. If, prior to the close of the 30-day comment period on the NOIRA, the board receives requests for a public hearing on the proposed regulation from at least 25 persons, such hearing shall be scheduled.~~

## **12 VAC 35-11-60. Notice of Comment Period.**

A. The Notice of Comment Period shall indicate that copies of the proposed regulation are available ~~from the Department of Mental Health, Mental Retardation and Substance Abuse Services~~ *on the department's website* and may be requested in writing from the contact person specified in the Notice of Comment Period.

B. The Notice of Comment Period shall indicate that copies of the statement of substance, issues, basis, purpose, and estimated impact of the proposed regulation may also be requested in writing.

C. ~~The Notice of Comment Period shall make provision for comments pertaining to the proposed regulation by regular mail, facsimile, on the Virginia Regulatory Townhall, or by electronic means.~~

## **12 VAC 35-11-70. Notice of meeting.**

A. For any meeting of the ~~Department of Mental Health, Mental Retardation and Substance Abuse Services board~~ or advisory committee at which the formation or adoption of regulation is anticipated, the subject shall be described in the Notice of Meeting, *which is posted electronically* and transmitted to the Registrar of Regulations for inclusion in The Virginia Register.

B. If the ~~Department of Mental Health, Mental Retardation and Substance Abuse Services board~~ anticipates action on a regulation for which an exemption to the Administrative Process Act is claimed under ~~§ 9-6.14:4.1~~ *2.2-4006* of the Code of Virginia, the Notice of Meeting shall indicate that a copy of the *proposed* regulation is available *on a state website or may be obtained* upon request *to the board* at least two days prior to the meeting. A copy of the regulation shall be made available to the public attending such meeting.

## **12 VAC 35-11-80. Public hearing on regulations.**

The ~~Department of Mental Health, Mental Retardation and Substance Abuse Services board~~ shall conduct a public hearing during the 60-day comment period following the publication of a proposed regulation or amendment to an existing regulation, unless at a noticed meeting the ~~Department of Mental Health, Mental Retardation and Substance Abuse Services board~~ determines that a hearing is not required.

---

# Proposed Regulations

---

## 12 VAC 35-11-90. Appointment of committees.

A. ~~The department of Mental Health, Mental Retardation and Substance Abuse Services may appoint an ad hoc advisory committee on behalf of the board whose responsibility shall be to assist in the review and development of regulations for the Department of Mental Health, Mental Retardation and Substance Abuse Services board.~~

B. ~~The department of Mental Health, Mental Retardation and Substance Abuse Services may appoint an ad hoc advisory committee on behalf of the board to provide professional specialization or technical assistance when the Department of Mental Health, Mental Retardation and Substance Abuse Services board determines that such expertise is necessary to address a specific regulatory issue or need or when groups of individuals register an interest in working with the agency board.~~

## 12 VAC 35-11-100. ~~Limitation of service. (Repealed.)~~

A. ~~An advisory committee which has been appointed by the Department of Mental Health, Mental Retardation and Substance Abuse Services may be dissolved by the Department of Mental Health, Mental Retardation and Substance Abuse Services when:~~

- ~~1. There is no response to the Notice of Intended Regulatory Action, or~~
- ~~2. The Department of Mental Health, Mental Retardation and Substance Abuse Services determines that the promulgation of the regulation is either exempt or excluded from the requirements of the Administrative Process Act (§ 9-6.14:4.1 of the Code of Virginia).~~

B. ~~An advisory committee shall remain in existence no longer than 12 months from its initial appointment.~~

- ~~1. If the Department of Mental Health, Mental Retardation and Substance Abuse Services determines that the specific regulatory need continues to exist beyond that time, it shall set a specific term for the committee of not more than six additional months.~~
- ~~2. At the end of that extended term, the Department of Mental Health, Mental Retardation and Substance Abuse Services shall evaluate the continued need and may continue the committee for additional six-month terms.~~

### PART V. PERIODIC REVIEWS.

## 12 VAC 35-11-110. Periodic review of regulations.

A. *Unless otherwise directed by executive order, the board shall review and receive comment on each of its existing regulations at least every three years to consider the effectiveness, efficiency, clarity and cost impact of the regulation in achieving its intended goals.*

B. *Notice of the review shall be transmitted to the Registrar of Regulations for inclusion in the Virginia Register and shall be sent to the notification list identified in 12 VAC 35-11-20.*

VA.R. Doc. No. R02-77; Filed October 22, 2002, 12:05 p.m.

## TITLE 14. INSURANCE

### STATE CORPORATION COMMISSION

#### Bureau of Insurance

**REGISTRAR'S NOTICE:** The State Corporation Commission is exempt from the Administrative Process Act in accordance with § 2.2-4002 A 2 of the Code of Virginia, which exempts courts, any agency of the Supreme Court, and any agency that by the Constitution is expressly granted any of the powers of a court of record.

**Title of Regulation:** 14 VAC 5-200. Rules Governing Long-Term Care Insurance (amending 14 VAC 5-200-20, 14 VAC 5-200-30, 14 VAC 5-200-40, 14 VAC 5-200-60, 14 VAC 5-200-75, 14 VAC 5-200-150, and 14 VAC 5-200-200; adding 14 VAC 5-200-77 and 14 VAC 5-200-153).

**Statutory Authority:** §§ 12.1-13 and 38.2-223 of the Code of Virginia.

**Public Hearing Date:** December 4, 2002 - 10 a.m.

Public comments may be submitted until November 22, 2002.

**Agency Contact:** Bob Wright, Special Projects Coordinator, Life and Health Division, Bureau of Insurance, P.O. Box 1157, Richmond, VA 23218, telephone (804) 371-9074, FAX (804) 371-9944, toll-free 1-800-552-7945 or e-mail [rwright@scc.state.va.us](mailto:rwright@scc.state.va.us).

#### Summary:

*The proposed amendments carry out the provisions of Chapter 334 of the 2002 Acts of Assembly that amended § 38.2-5206 of the Code of Virginia to require the State Corporation Commission to adopt standards regarding the initial filing requirements and premium rate schedule increases similar to those set forth in the model long-term care regulation developed by the National Association of Insurance Commissioners.*

*Significant revisions (i) provide standards that initial rate filings must meet; (ii) provide requirements for premium rate schedule increases; and (iii) add definitions that support the proposed new rules.*

*Changes also are proposed that either modify effective dates or are otherwise nonsubstantive in nature.*

AT RICHMOND, OCTOBER 23, 2002

COMMONWEALTH OF VIRGINIA

At the relation of the

STATE CORPORATION COMMISSION

CASE NO. INS-2002-00118

**Ex Parte:** In the matter of  
Adopting Revisions to the Rules  
Governing Long-Term Care Insurance

## ORDER TO TAKE NOTICE

Section 12.1-13 of the Code of Virginia provides that the Commission shall have the power to promulgate rules and regulations in the enforcement and administration of all laws within its jurisdiction, and § 38.2-223 of the Code of Virginia provides that the Commission may issue any rules and regulations necessary or appropriate for the administration and enforcement of Title 38.2 of the Code of Virginia.

The rules and regulations issued by the Commission pursuant to § 38.2-223 of the Code of Virginia are set forth in Title 14 of the Virginia Administrative Code.

The Bureau of Insurance (the "Bureau") has submitted to the Commission proposed revisions to Chapter 200 of Title 14 of the Virginia Administrative Code entitled "Rules Governing Long-Term Care Insurance," which amend the rules at 14 VAC 5-200-20, 14 VAC 5-200-30, 14 VAC 5-200-40, 14 VAC 5-200-60, 14 VAC 5-200-75, 14 VAC 5-200-150, and 14 VAC 5-200-200, and propose new rules to be designated as 14 VAC 5-200-77 and 14 VAC 5-200-153.

The proposed revisions carry out those provisions of House Bill 1125, adopted by the General Assembly in its 2002 Session, that amended § 38.2-5206 of the Code of Virginia to require the Commission to adopt standards regarding the initial filing requirements and premium rate schedule increases similar to those set forth in the model long-term care regulation developed by the National Association of Insurance Commissioners.

The Bureau has recommended to the Commission that the proposed revisions should be considered for adoption with an effective date of April 1, 2003.

The Bureau also has recommended to the Commission that a hearing should be held to consider the proposed revisions, and the Commission is of the opinion that a hearing should be held to consider the proposed revisions.

THEREFORE, IT IS ORDERED THAT:

(1) The proposed revisions to the "Rules Governing Long-Term Care Insurance," which amend the rules at 14 VAC 5-200-20, 14 VAC 5-200-30, 14 VAC 5-200-40, 14 VAC 5-200-60, 14 VAC 5-200-75, 14 VAC 5-200-150, and 14 VAC 5-200-200, and propose new rules to be designated as 14 VAC 5-200-77 and 14 VAC 5-200-153, be attached hereto and made a part hereof.

(2) All interested persons TAKE NOTICE that the Commission shall conduct a hearing in the Commission's Courtroom, 2<sup>nd</sup> Floor, Tyler Building, 1300 East Main Street, Richmond, Virginia 23219 at 10:00 a.m. on December 4, 2002, to consider the adoption of the revisions proposed by the Bureau of Insurance with an effective date of April 1, 2003.

(3) On or before November 22, 2002, any person desiring to comment in support of or in opposition to the proposed revisions shall file such comments in writing with the Clerk of the Commission, Document Control Center, P.O. Box 2118, Richmond, Virginia 23218.

(4) On or before November 22, 2002, any person intending to appear and be heard at the hearing on the proposed revisions

shall file written notice of his intention to do so, which notice shall include his comments in support of or in opposition to the proposed revisions, with the Clerk of the Commission at the address set forth in the preceding paragraph.

(5) All filings made under paragraph (3) or (4) shall contain a reference to Case No. INS-2002-00118.

(6) AN ATTESTED COPY hereof, together with a copy of the proposed revisions, shall be sent by the Clerk of the Commission to the Bureau of Insurance in care of Deputy Commissioner Gerald A. Milsky, who forthwith shall give further notice of the proposed adoption of the revisions to the rules by mailing a copy of this Order, together with the attached proposed revisions, to all insurers licensed by the Commission to write long-term care insurance in the Commonwealth of Virginia.

(7) The Commission's Division of Information Resources forthwith shall cause a copy of this Order, together with the attached proposed revisions, to be forwarded to the Virginia Registrar of Regulations for appropriate publication in the Virginia Register of Regulations.

(8) On or before October 29, 2002, the Commission's Division of Information Resources shall make available this Order and the attached proposed revisions on the Commission's website, <http://www.state.va.us/scc/caseinfo/orders.htm>.

(9) The Bureau of Insurance shall file with the Clerk of the Commission an affidavit of compliance with the notice requirements of paragraph (6) above.

**14 VAC 5-200-20. Contracts effective prior to ~~February 1, 2002~~ April 1, 2003.**

Except as otherwise specifically provided, each long-term care *insurance* policy delivered or issued for delivery in this Commonwealth prior to ~~February 1, 2002~~ April 1, 2003, shall be subject to this chapter as it existed at the time the policy was ~~issued~~ delivered or issued for delivery.

**14 VAC 5-200-30. Applicability and scope.**

Except as otherwise specifically provided, this chapter applies to all long-term care Insurance policies delivered or issued for delivery in this Commonwealth, on or after ~~February 1, 2002~~ April 1, 2003, by insurers, fraternal benefit societies, health services plans, health maintenance organizations, cooperative nonprofit life benefit companies or mutual assessment life, accident and sickness insurers.

**14 VAC 5-200-40. Definitions.**

The following words and terms when used in this chapter shall have the following meanings, unless the context clearly indicates otherwise:

"*Applicant*" means in the case of an individual long-term care insurance policy, the person who seeks to contract for such benefits, or in the case of a group long-term care insurance policy, the proposed certificateholder.

"*Certificate*" means any certificate or evidence of coverage issued under a group long-term care insurance policy, which policy has been delivered or issued for delivery in this Commonwealth.

---

# Proposed Regulations

---

*"Commission"* means the Virginia State Corporation Commission.

*"Exceptional increase"* means only those increases filed by an insurer and identified as exceptional for which the commission determines the need for the premium rate increase is justified (i) due to changes in laws or regulations applicable to long-term care coverage in this Commonwealth, or (ii) due to increased and unexpected utilization that affects the majority of insurers of similar products. Except as provided in 14 VAC 5-200-153, exceptional increases are subject to the same requirements as other premium rate schedule increases. The commission, in determining that the necessary basis for an exceptional increase exists, shall also determine any potential offsets to higher claims costs.

*"Expected loss ratio"* means the ratio of the present value of future premiums benefits to the present value of future benefits premiums over the entire period of the contract.

*"Group long-term care insurance"* means a long-term care insurance policy which complies with § 38.2-3521.1 or § 38.2-3522.1 of the Code of Virginia delivered or issued for delivery in this Commonwealth.

*"Incidental,"* as used in 14 VAC 5-200-153 J, means that the value of the long-term care benefits provided is less than 10% of the total value of the benefits provided over the life of the policy. These values shall be measured as of the date of issue.

*"Insurer"* means any insurance company, health services plan, fraternal benefit society, health maintenance organization, cooperative nonprofit life benefit company, or mutual assessment life, accident and sickness insurer.

*"Long-term care insurance"* means any insurance policy or rider primarily advertised, marketed, offered or designed to provide coverage for not less than 12 consecutive months for each covered person on an expense incurred, indemnity, prepaid, or other basis, for one or more necessary or medically necessary diagnostic, preventive, therapeutic, rehabilitative, maintenance, personal care, mental health or substance abuse services, provided in a setting other than an acute care unit of a hospital. Such term includes group and individual annuities and life insurance policies or riders which provide directly or which supplement long-term care insurance issued by insurers. Such term also includes a policy or rider which provides for payment of benefits based upon cognitive impairment or the loss of functional capacity. Long-term care insurance shall not include any insurance policy which is offered primarily to provide basic Medicare supplement coverage, basic hospital expense coverage, basic medical-surgical expense coverage, hospital confinement indemnity coverage, major medical expense coverage, disability income or related asset-protection coverage, accident only coverage, specified disease or specified accident coverage, or limited benefit health coverage. With regard to life insurance, this term does not include life insurance policies which accelerate the death benefit specifically for one or more of the qualifying events of terminal illness, medical conditions requiring extraordinary medical intervention, or permanent institutional confinement, and which provide the option of a lump-sum payment for those

benefits and in which neither the benefits nor the eligibility for the benefits is conditioned upon the receipt of long-term care. Notwithstanding any other provision contained herein, any product advertised, marketed or offered as long-term care insurance shall be subject to the provisions of this chapter. Health maintenance organizations, cooperative nonprofit life benefit companies and mutual assessment life, accident and sickness insurers shall apply to the commission for approval to provide long-term care insurance prior to issuing this type of coverage.

*"Policy"* means any individual or group policy of insurance, contract, subscriber agreement, certificate, rider or endorsement delivered or issued for delivery in this Commonwealth by an insurer.

*"Qualified actuary"* means a member in good standing of the American Academy of Actuaries.

*"Similar policy forms"* means all of the long-term care insurance policies and certificates issued by an insurer in the same long-term care benefit classification as the policy form being considered. Certificates of groups as set forth in subsections A and C of § 38.2-3522.1 of the Code of Virginia are not considered similar to certificates or policies otherwise issued as long-term care insurance, but are similar to other comparable certificates with the same long-term care benefit classifications. For purposes of determining similar policy forms, long-term care benefit classifications are defined as follows: institutional long-term care benefits only, noninstitutional long-term care benefits only, or comprehensive long-term care benefits.

## **14 VAC 5-200-60. Policy practices and provisions.**

A. Renewability. The terms "guaranteed renewable" and "noncancellable" shall not be used in any individual long-term care insurance policy without further explanatory language in accordance with the disclosure requirements of 14 VAC 5-200-70.

1. No such policy issued to an individual shall contain renewal provisions other than "guaranteed renewable or noncancellable."

2. The term "guaranteed renewable" may be used only when the insured has the right to continue the long-term care insurance in force by the timely payment of premiums and when the insurer has no unilateral right to make any change in any provision of the policy or rider while the insurance is in force, and cannot decline to renew, except that rates may be revised by the insurer on a class basis.

3. The term "noncancellable" may be used only when the insured has the right to continue the long-term care insurance in force by the timely payment of premiums during which period the insurer has no unilateral right to make any change in any provision of the insurance or in the premium rate.

B. Limitations and exclusions. No policy may be delivered or issued for delivery in this Commonwealth as long-term care insurance if such policy limits or excludes coverage by type of illness, treatment, medical condition or accident, except as follows:



1. Preexisting conditions or diseases, subject to *subsection B of § 38.2-5204 B* of the Code of Virginia;

2. Mental or nervous disorders; however, this shall not permit exclusion or limitation of benefits on the basis of Alzheimer's Disease, senile dementia, organic brain disorder or other similar diagnoses;

3. Alcoholism and drug addiction;

4. Illness, treatment or medical condition arising out of:

a. War or act of war (whether declared or undeclared);

b. Participation in a felony, riot or insurrection;

c. Service in the armed forces or units auxiliary thereto;

d. Suicide (sane or insane), attempted suicide or intentionally self-inflicted injury; or

e. Aviation (this exclusion applies only to nonfare-paying passengers).

5. Treatment provided in a government facility (unless otherwise required by law), services for which benefits are available under Medicare or other governmental program (except Medicaid), any state or federal workers' compensation, employer's liability or occupational disease law, or any motor vehicle no-fault law, services provided by a member of the covered person's immediate family and services for which no charge is normally made in the absence of insurance.

6. This subsection is not intended to prohibit exclusions and limitations by type of provider or territorial limitations.

C. Extension of benefits. Termination of long-term care insurance shall be without prejudice to any benefits payable for institutionalization if such institutionalization began while the long-term care insurance was in force and continues without interruption after termination. Such extension of benefits beyond the period the long-term care insurance was in force may be limited to the duration of the benefit period, if any, or to payment of the maximum benefits and may be subject to any policy waiting period, and all other applicable provisions of the policy.

D. Continuation or conversion.

1. Group long-term care insurance issued in this Commonwealth on or after December 1, 2000, shall provide covered individuals with a basis for continuation of coverage or a basis for conversion of coverage.

2. For the purposes of this chapter, "a basis for continuation of coverage" means a policy provision which maintains coverage under the existing group policy when such coverage would otherwise terminate and is subject only to the continued timely payment of premium when due. Group policies which restrict provision of benefits and services to, or contain incentives to use, certain providers and/or facilities may provide continuation benefits which are substantially equivalent to the benefits of the existing group policy. The substantial equivalency of benefits is subject to review by the commission, and in doing so, the commission shall take into consideration the differences between managed care and non-managed care plans, including, but

not limited to, provider system arrangements, service availability, benefit levels and administrative complexity.

3. For the purposes of this chapter, "a basis for conversion of coverage" means a policy provision stating that an individual whose coverage under the group policy would otherwise terminate or has been terminated for any reason, including discontinuance of the group policy in its entirety or with respect to an insured class, and who has been continuously insured under the group policy (and any group policy which it replaced) for at least six months immediately prior to termination, shall be entitled to the issuance of a converted policy by the insurer under whose group policy he or she is covered, without evidence of insurability.

4. For the purposes of this chapter, "converted policy" means an individual policy of long-term care insurance providing benefits identical to or benefits determined by the commission to be substantially equivalent to or in excess of those provided under the group policy from which conversion is made. Where the group policy from which conversion is made restricts provision of benefits and services to, or contains incentives to use, certain providers and/or facilities, the insurer, in making a determination as to the substantial equivalency of benefits, shall take into consideration the differences between managed care and non-managed care plans, including, but not limited to, provider system arrangements, service availability, benefit levels and administrative complexity. The determination of substantial equivalency is subject to review by the commission.

5. Written application for the converted policy shall be made and the first premium due, if any, shall be paid as directed by the insurer not later than 31 days after termination of coverage under the group policy. The converted policy shall be issued effective on the day following the termination of coverage under the group policy and shall be renewable annually.

6. Unless the group policy from which conversion is made replaced previous group coverage, the premium for the converted policy shall be calculated on the basis of the insured's age at inception of coverage under the group policy from which conversion is made. Where the group policy from which conversion is made replaced previous group coverage, the premium for the converted policy shall be calculated on the basis of the insured's age at inception of coverage under the initial group policy replaced.

7. Continuation of coverage or issuance of a converted policy shall be mandatory, except where:

a. Termination of group coverage resulted from an individual's failure to make any required payment of premium or contribution when due; or

b. The terminating coverage is replaced, as to an individual insured, not later than 31 days after termination, by group coverage effective on the day following the termination of coverage:

(1) Providing benefits identical to or benefits substantially equivalent to or in excess of those provided by the terminating coverage; and

---

## Proposed Regulations

---

(2) The premium for which is calculated in a manner consistent with the requirements of subdivision 6 of this subsection. The determination of substantial equivalency is subject to review by the commission.

8. Notwithstanding any other provision of this section, a converted policy issued to an individual who at the time of conversion is covered by another long-term care insurance policy which provides benefits on the basis of incurred expenses may contain a provision which results in a reduction of benefits payable if the benefits provided under the additional coverage, together with the full benefits provided by the converted policy, would result in payment of more than 100% of incurred expenses. Such provision shall only be included in the converted policy if the converted policy also provides for a premium decrease or refund which reflects the reduction in benefits payable.

9. The converted policy may provide that the benefits payable under the converted policy, together with the benefits payable under the group policy from which conversion is made, shall not exceed those that would have been payable had the individual's coverage under the group policy remained in force and effect.

10. Notwithstanding any other provision of this section, any insured individual whose eligibility for group long-term care coverage is based upon his or her relationship to another person shall be entitled to continuation of coverage under the group policy upon termination of the qualifying relationship by death or dissolution of marriage.

11. For the purposes of this chapter, a "Managed Care Plan" is a health care or assisted living arrangement designed to coordinate patient care or control costs through utilization review, case management or use of specific provider networks.

E. Discontinuance and replacement. If a group long-term care policy is replaced by another group long-term care policy issued to the same policyholder, the succeeding insurer shall offer coverage to all persons covered under the previous group policy on its date of termination. Coverage provided or offered to individuals by the insurer and premiums charged to persons under the new group policy:

1. Shall not result in any exclusion for preexisting conditions that would have been covered under the group policy being replaced; and
2. Shall not vary or otherwise depend on the individual's health or disability status, claim experience or use of long-term care services.

F. Premium increases.

1. The premium charged to an insured shall not increase due to either:
  - a. The increasing age of the insured at ages beyond age 65; or
  - b. The duration the insured has been covered under the policy.
2. The purchase of additional coverage shall not be considered a premium rate increase, but for purposes of the

calculation required under 14 VAC 5-200-185, the portion of the additional coverage shall be added to and considered part of the initial annual premium.

3. A reduction in benefits shall not be considered a premium change, but for purposes of the calculation under 14 VAC 5-200-185, the initial annual premium shall be based on the reduced benefits.

### **14 VAC 5-200-75. Required disclosure of rating practices to consumer.**

A. This section shall apply as follows:

1. Except as provided in subdivision 2 of this subsection, this section applies to any long-term care policy or certificate issued in this Commonwealth on or after August 1, 2002.
2. For certificates issued on or after February 1, 2002, under a group long-term care insurance policy as defined in 14 VAC 5-200-40, which policy was in force on February 1, 2002, the provisions of this section shall apply on the policy anniversary on or after February 1, 2003.

B. Other than policies for which no applicable premium rate or rate schedule increases can be made, insurers shall provide all of the information listed in this subsection to the applicant at the time of application or enrollment, unless the method of application does not allow for delivery at that time. In such a case, an insurer shall provide all of the information listed in this section to the applicant no later than at the time of delivery of the policy or certificate.

1. A statement that the policy may be subject to rate increases in the future;
2. An explanation of potential future premium rate revisions, and the policyholder's or certificateholder's option in the event of a premium rate revision;
3. The premium rate or rate schedules applicable to the applicant that will be in effect until a request is made for an increase;
4. A general explanation for applying premium rate or rate schedule adjustments that shall include:
  - a. A description of when premium rate or rate schedule adjustments will be effective (e.g., next anniversary date, next billing date, etc.); and
  - b. The right to a revised premium rate or rate schedule as provided in subdivision 2 of this subsection if the premium rate or rate schedule is changed;
5. a. Information regarding each premium rate increase on this policy form or similar policy forms over the past 10 years for this Commonwealth or any other state that, at a minimum, identifies:
  - (1) The policy forms for which premium rates have been increased;
  - (2) The calendar years when the form was available for purchase; and

(3) The amount or percentage of each increase. The percentage may be expressed as a percentage of the premium rate prior to the increase, and may also be expressed as minimum and maximum percentages if the rate increase is variable by rating characteristics.

b. The insurer may, in a fair manner, provide additional explanatory information related to the rate increases.

c. An insurer shall have the right to exclude from the disclosure premium rate increases that only apply to blocks of business acquired from other nonaffiliated insurers or the long-term care policies acquired from other nonaffiliated insurers when those increases occurred prior to the acquisition.

d. If an acquiring insurer files for a rate increase on a long-term care policy form acquired from nonaffiliated insurers or a block of policy forms acquired from nonaffiliated insurers on or before the later of (i) August 1, 2002, or February 1, 2003, as is applicable pursuant to subsection A of this section, or (ii) the end of a 24-month period following the acquisition of the block or policies, the acquiring insurer may exclude that rate increase from the disclosure. However, the nonaffiliated selling company shall include the disclosure of that rate increase in accordance with subdivision 5 a of this subsection.

e. If the acquiring insurer in subdivision 5 d of this subsection files for a subsequent rate increase, even within the 24-month period, on the same policy form acquired from nonaffiliated insurers or block of policy forms acquired from nonaffiliated insurers referenced in subdivision 5 d of this subsection, the acquiring insurer shall make all disclosures required by subdivision 5 of this subsection, including disclosure of the earlier rate increase referenced in subdivision 5 d of this subsection.

C. An applicant shall sign an acknowledgement at the time of application, unless the method of application does not allow for signature at that time, that the insurer made the disclosure required under subdivisions B 1 and 5 of this section. If due to the method of application the applicant cannot sign an acknowledgement at the time of application, the applicant shall sign no later than at the time of delivery of the policy or certificate.

D. An insurer shall use Forms B and E dated February 1, 2002, or as later modified by the Bureau of Insurance, to comply with the requirements of subsections A B and B C of this section.

E. An insurer shall provide notice of an upcoming premium rate schedule increase to all policyholders or certificateholders, if applicable, at least 60 days prior to the implementation of the premium rate schedule increase by the insurer. The notice shall include the information required by subsection B of this section when the rate increase is implemented.

#### **14 VAC 5-200-77. Initial filing requirements.**

A. This section applies to any long-term care policy approved in this Commonwealth on or after October 1, 2003.

B. An insurer shall provide the information listed in this subsection to the commission and receive approval of the form prior to making a long-term care insurance form available for sale.

1. A copy of the disclosure documents required in 14 VAC 5-200-75; and

2. An actuarial certification consisting of at least the following:

a. A statement that the initial premium rate schedule is sufficient to cover anticipated costs under moderately adverse experience and that the premium rate schedule is reasonably expected to be sustainable over the life of the form with no future premium increases anticipated;

b. An explanation for supporting subdivision 2 a of this subsection, including (i) the comparison of premium rates filed containing the moderately adverse experience and the premium rates that would apply without that margin and (ii) a description of the testing of pricing assumptions that was done to support the conclusion that the filed premium rates are sustainable over the life of the form;

c. A statement that the policy design and coverage provided have been reviewed and taken into consideration;

d. A statement that the underwriting and claims adjudication processes have been reviewed and taken into consideration;

e. A complete description of the basis for contract reserves that are anticipated to be held under the form, to include:

(1) Sufficient detail or sample calculations provided so as to have a complete depiction of the reserve amounts to be held;

(2) A statement that the assumptions used for reserves contain reasonable margins for adverse experience;

(3) A statement that the net valuation premium for renewal years does not increase (except for attained-age rating); and

(4) A statement that the difference, in aggregate, between the gross premium and the net valuation premium for renewal years is sufficient to cover expected renewal expenses; or if such a statement cannot be made, a complete description of the situations where this does not occur. When the difference between the gross premium and the renewal net valuation premiums is not sufficient to cover expected renewal expenses, the description provided should demonstrate the type and level of change in the reserve assumptions that would be necessary for the difference to be sufficient.

(a) An aggregate distribution of anticipated issues may be used as long as the underlying gross premiums maintain a reasonably consistent relationship;

---

# Proposed Regulations

---

*(b) If the gross premiums for certain age groups appear to be inconsistent with this requirement, the commission may request a demonstration based on a standard age distribution; and*

*f. (1) A statement that the premium rate schedule is not less than the premium rate schedule for existing similar policy forms also available from the insurer except for reasonable differences attributable to benefits; or*

*(2) A comparison of the premium rate schedules for similar policy forms that are currently available from the insurer with an explanation of the differences. It is not expected that the insurer will need to provide a comparison of every age and set of benefits, period of payment or elimination period. A broad range of expected combinations is to be provided in a manner designed to provide a fair presentation for review by the commission.*

3. An actuarial memorandum that includes:

*a. A description of the basis on which the long-term care insurance premium rates were determined;*

*b. A description of the basis for the reserves;*

*c. A summary of the type of policy, benefits, renewability, general marketing method, and limits on ages of issuance;*

*d. A description and a table of each actuarial assumption used. For expenses, an insurer must include percentage of premium dollars per policy and dollars per unit of benefits, if any;*

*e. A description and a table of the anticipated policy reserves and additional reserves to be held in each future year for active lives;*

*f. The estimated average annual premium per policy and the average issue age; and*

*g. A statement that includes a description of the types of underwriting used, such as medical underwriting or functional assessment underwriting. Concerning a group policy, the statement shall indicate whether the enrollee or any dependent will be underwritten and when underwriting occurs.*

## **14 VAC 5-200-150. Loss ratio.**

*A. This section shall apply to all long-term care insurance policies or certificates except those covered under 14 VAC 5-200-77 and 14 VAC 5-200-153.*

*A- B. Benefits under individual long-term care insurance policies shall be deemed reasonable in relation to premiums provided the expected loss ratio is at least 60% calculated in a manner which provides for adequate reserving of the long-term care insurance risk. In evaluating the expected loss ratio, due consideration shall be given to all relevant factors, including:*

1. Statistical credibility of incurred claims experience and earned premiums;

2. The period for which rates are computed to provide coverage;

3. Experienced and projected trends;

4. Concentration of experience within early policy duration;

5. Expected claim fluctuation;

6. Experience refunds, adjustments or dividends;

7. Renewability features;

8. All appropriate expense factors;

9. Interest;

10. Experimental nature of the coverage;

11. Policy reserves;

12. Mix of business by risk classification; and

13. Product features such as long elimination periods, high deductibles and high maximum limits.

Demonstrations of loss ratios shall be made in compliance with the Rules Governing the Filing of Rates for Individual and Certain Group Accident and Sickness Insurance Policy Forms, Chapter 130 (14 VAC 5-130-10 ~~et seq.~~) of this title.

~~B- C.~~ Subsection ~~A B~~ of this section shall not apply to life insurance policies that accelerate benefits for long-term care. A life insurance policy that funds long-term care benefits entirely by accelerating the death benefit is considered to provide reasonable benefits in relation to premiums paid, if the policy complies with all of the following provisions:

1. The interest credited internally to determine cash value accumulations, including long-term care, if any, are guaranteed not to be less than the minimum guaranteed interest rate for cash value accumulations without long-term care set forth in the policy;

2. The portion of the policy that provides life insurance benefits meets the nonforfeiture requirements of Chapter 32 (§ 38.2-3200 et seq.) of Title 38.2 of the Code of Virginia;

3. If an application for a long-term care insurance contract or certificate is approved, the issuer shall deliver the contract or certificate of insurance to the applicant no later than 30 days after the date of approval;

4. At the time of policy delivery, a policy summary shall be delivered for an individual life insurance policy that provides long-term care benefits within the policy or by rider. In the case of direct response solicitations, the insurer shall deliver the policy summary upon the applicant's request, but regardless of request shall make delivery no later than at the time of policy delivery. In addition to complying with all applicable requirements, the summary shall also include:

a. An explanation of how the long-term care benefit interacts with other components of the policy, including deductions from death benefits;

b. An illustration of the amount of benefits, the length of benefit, and the guaranteed lifetime benefits if any, for each covered person;

- c. Any exclusions, reductions and limitations on benefits of long-term care;
  - d. A statement that any long-term care inflation protection option required by 14 VAC 5-200-100 is not available under this policy;
  - e. If applicable to the policy type, the summary shall also include:
    - (1) A disclosure of the effects of exercising other rights under the policy;
    - (2) A disclosure of guarantees related to long-term care costs of insurance charges; and
    - (3) Current and projected maximum lifetime benefits; and
  - f. The provisions of the policy summary listed above may be incorporated into a basic illustration or into the life insurance policy summary;
5. Any time a long-term care benefit, funded through a life insurance vehicle by the acceleration of the death benefit, is in benefit payment status, a monthly report shall be provided to the policyholder. The report shall include:
- a. Any long-term care benefits paid out during the month;
  - b. An explanation of any changes in the policy, e.g., death benefits or cash values, due to long-term care benefits being paid out; and
  - c. The amount of long-term care benefits existing or remaining;
6. Any policy illustration that meets the applicable requirements of 14 VAC 5-40-10 ~~et seq.~~; and
7. An actuarial memorandum is filed with the Bureau of Insurance that includes:
- a. A description of the basis on which the long-term care rates were determined;
  - b. A description of the basis for the reserves;
  - c. A summary of the type of policy, benefits, renewability, general marketing method, and limits on ages of issuance;
  - d. A description and a table of each actuarial assumption used. For expenses, an insurer must include percentage of premium dollars per policy and dollars per unit of benefits, if any;
  - e. A description and a table of the anticipated policy reserves and additional reserves to be held in each future year for active lives;
  - f. The estimated average annual premium per policy and the average issue age;
  - g. A statement as to whether underwriting is performed at the time of application. The statement shall indicate whether underwriting is used and, if used, the statement shall include a description of the type or types of underwriting used, such as medical underwriting or functional assessment underwriting. Concerning a group

policy, the statement shall indicate whether the enrollee or any dependent will be underwritten and when underwriting occurs; and

h. A description of the effect of the long-term care policy provision on the required premiums, nonforfeiture values and reserves on the underlying life insurance policy, both for active lives and those in long-term care claim status.

**14 VAC 5-200-153. Premium rate schedule increases.**

A. This section shall apply as follows:

1. Except as provided in subdivision 2 of this subsection, this section applies to any long-term care policy or certificate issued in this Commonwealth on or after October 1, 2003.

2. For certificates issued on or after April 1, 2003, under a group long-term care insurance policy as set forth in subsections A and C of § 38.2-3522.1 of the Code of Virginia, which policy was in force on April 1, 2003, the provisions of this section shall apply on the policy anniversary following April 1, 2004.

B. An insurer shall request approval of a pending premium rate schedule increase, including an exceptional increase, to the commission prior to the notice to the policyholders and shall include:

1. Information required by 14 VAC 5-200-75;

2. Certification by a qualified actuary that:

a. If the requested premium rate schedule increase is implemented and the underlying assumptions, which reflect moderately adverse conditions, are realized, no further premium rate schedule increases are anticipated;

b. The premium rate filing is in compliance with the provisions of this section;

3. An actuarial memorandum justifying the rate schedule change request that includes:

a. Lifetime projections of earned premiums and incurred claims based on the filed premium rate schedule increase; and the method and assumptions used in determining the projected values, including reflection of any assumptions that deviate from those used for pricing other forms currently available for sale;

(1) Annual values for the five years preceding and the three years following the valuation date shall be provided separately;

(2) The projections shall include the development of the lifetime loss ratio, unless the rate increase is an exceptional increase;

(3) The projections shall demonstrate compliance with subsection C of this section; and

(4) For exceptional increases,

(a) The projected experience should be limited to the increases in claims expenses attributable to the approved reasons for the exceptional increase; and

---

## Proposed Regulations

---

(b) In the event the commission determines as provided in the definition of exceptional increase in 14 VAC 5-200-40 that offsets may exist, the insurer shall use appropriate net projected experience;

b. Disclosure of how reserves have been incorporated in this rate increase whenever the rate increase will trigger contingent benefit upon lapse;

c. Disclosure of the analysis performed to determine why a rate adjustment is necessary, which pricing assumptions were not realized and why, and what other actions taken by the company have been relied on by the actuary;

d. A statement that policy design, underwriting and claims adjudication practices have been taken into consideration; and

e. In the event that it is necessary to maintain consistent premium rates for new policies and policies receiving a rate increase, the insurer will need to file composite rates reflecting projections of new policies;

4. A statement that renewal premium rate schedules are not greater than new business premium rate schedules except for differences attributable to benefits, unless sufficient justification is provided to the commission; and

5. Sufficient information for review and approval of the premium rate schedule increase by the commission.

C. All premium rate schedule increases shall be determined in accordance with the following requirements:

1. Exceptional increases shall provide that 70% of the present value of projected additional premiums from the exceptional increase will be returned to policyholders in benefits;

2. Premium rate schedule increases shall be calculated such that the sum of the accumulated value of incurred claims, without the inclusion of active life reserves, and the present value of future projected incurred claims, without the inclusion of active life reserves, will not be less than the sum of the following:

a. The accumulated value of the initial earned premium times 58%;

b. Eighty-five percent of the accumulated value of prior premium rate schedule increases on an earned basis;

c. The present value of future projected initial earned premiums times 58%; and

d. Eighty-five percent of the present value of future projected premiums not in subdivision 2 c of this subsection on an earned basis;

3. In the event that a policy form has both exceptional and other increases, the values in subdivisions 2 b and d of this subsection will also include 70% for exceptional rate increase amounts; and

4. All present and accumulated values used to determine rate increases shall use the maximum valuation interest rate for contract reserves as specified in § 38.2-3132 of the

Code of Virginia. The actuary shall disclose as part of the actuarial memorandum the use of any appropriate averages.

D. For each rate increase that is implemented, the insurer shall file for approval by the commission updated projections, as defined in subdivision B 3 a of this section, annually for the next three years and include a comparison of actual results to projected values. The commission may extend the period to greater than three years if actual results are not consistent with projected values from prior projections. For group insurance policies that meet the conditions in subsection K of this section, the projections required by subdivision B 3 a of this section shall be provided to the policyholder in lieu of filing with the commission.

E. If any increased premium rate in the revised premium rate schedule is greater than 200% of the comparable rate in the initial premium schedule, the premiums exceeding 200% shall be clearly identified and lifetime projections, as defined in subdivision B 3 a of this section, shall be filed for approval by the commission every five years following the end of the required period in subsection D of this section. For group insurance policies that meet the conditions in subsection K of this section, the projections required by this subsection shall be provided to the policyholder in lieu of filing with the commission.

F. 1. If the commission has determined that the actual experience following a rate increase does not adequately match the projected experience and that the current projections under moderately adverse conditions demonstrate that incurred claims will not exceed proportions of premiums specified in subsection C of this section, the commission may require the insurer to implement any of the following:

a. Premium rate schedule adjustments; or

b. Other measures to reduce the difference between the projected and actual experience.

It is to be expected that the actual experience will not exactly match the insurer's projections. During the period that projections are monitored as described in subsections D and E of this section, the commission should determine that there is not an adequate match if the differences in earned premiums and incurred claims are not in the same direction (both actual values higher or lower than projections) or the difference as a percentage of the projected is not of the same order.

2. In determining whether the actual experience adequately matches the projected experience, consideration should be given to subdivision B 3 e of this section, if applicable.

G. If the majority of the policies or certificates to which the increase is applicable are eligible for the contingent benefit upon lapse, the insurer shall file:

1. A plan, subject to commission approval, for improved administration or claims processing designed to eliminate the potential for further deterioration of the policy form requiring further premium rate schedule increases or to demonstrate that appropriate administration and claims processing have been implemented or are in effect;

otherwise the commission may impose the condition in subsection H of this section; and

2. The original anticipated lifetime loss ratio, and the premium rate schedule increase that would have been calculated according to subsection C of this section had the greater of the original anticipated lifetime loss ratio or 58% been used in the calculations described in subdivisions C 2 a and c of this section.

H. 1. For a rate increase filing that meets the following criteria, the commission shall review, for all policies included in the filing, the projected lapse rates and past lapse rates during the 12 months following each increase to determine if significant adverse lapsation has occurred or is anticipated:

- a. The rate increase is not the first rate increase requested for the specific policy form or forms;
- b. The rate increase is not an exceptional increase; and
- c. The majority of the policies or certificates to which the increase is applicable are eligible for the contingent benefit upon lapse.

2. In the event significant adverse lapsation has occurred, is anticipated in the filing or is evidenced in the actual results as presented in the updated projections provided by the insurer following the requested rate increase, the commission may determine that a rate spiral exists. Following the determination that a rate spiral exists, the commission may require the insurer to offer, without underwriting, to all in force insureds subject to the rate increase the option to replace existing coverage with any other long-term care insurance product being offered by the insurer or its affiliates.

a. The offer shall:

- (1) Be subject to the approval of the commission;
- (2) Be based on actuarially sound principles, but not be based on attained age; and
- (3) Provide that maximum benefits under any new policy accepted by an insured shall be reduced by comparable benefits already paid under the existing policy.

b. The insurer shall maintain the experience of all the replacement insureds separate from the experience of insureds originally issued the policy forms. In the event of a request for a rate increase on the policy form, the rate increase shall be limited to the lesser of:

- (1) The maximum rate increase determined based on the combined experience; or
- (2) The maximum rate increase determined based only on the experience of the insureds originally issued the form plus 10%.

I. If the commission determines that the insurer has exhibited a persistent practice of filing inadequate initial premium rates for long-term care insurance, the commission may, in addition to the provisions of subsection H of this section, prohibit the insurer from either of the following:

1. Filing and marketing comparable coverage for a period of up to five years; or

2. Offering all other similar coverages and limiting marketing of new applications to the products subject to recent premium rate schedule increases.

J. Subsections A through I of this section shall not apply to policies for which the long-term care benefits provided by the policy are incidental, as defined in 14 VAC 5-200-40, if the policy complies with all of the following provisions:

1. The interest credited internally to determine cash value accumulations, including long-term care, if any, are guaranteed not to be less than the minimum guaranteed interest rate for cash value accumulations without long-term care set forth in the policy;

2. The portion of the policy that provides insurance benefits other than long-term care coverage meets the nonforfeiture requirements as applicable in any of the following:

- a. Sections 38.2-3200 through 38.2-3218 of the Code of Virginia, and
- b. Sections 38.2-3219 through 38.2-3229 of the Code of Virginia;

3. The policy meets the disclosure requirements of §§ 38.2-5207.1 and 38.2-5207.2 of the Code of Virginia;

4. The portion of the policy that provides insurance benefits other than long-term care coverage meets the requirements as applicable in the following:

- a. Policy illustrations as required by 14 VAC 5-40; and
- b. Disclosure requirements in 14 VAC 5-40.

5. An actuarial memorandum is filed with the commission that includes:

- a. A description of the basis on which the long-term care rates were determined;
- b. A description of the basis for the reserves;
- c. A summary of the type of policy, benefits, renewability, general marketing method, and limits on ages of issuance;

d. A description and a table of each actuarial assumption used. For expenses, an insurer shall include percent of premium dollars per policy and dollars per unit of benefits, if any;

e. A description and a table of the anticipated policy reserves and additional reserves to be held in each future year for active lives;

f. The estimated average annual premium per policy and the average issue age;

g. A statement as to whether underwriting is performed at the time of application. The statement shall indicate whether underwriting is used and, if used, the statement shall include a description of the type or types of underwriting used, such as medical underwriting or functional assessment underwriting. Concerning a group

---

# Proposed Regulations

---

policy, the statement shall indicate whether the enrollee or any dependent will be underwritten and when underwriting occurs; and

*h. A description of the effect of the long-term care policy provision on the required premiums, nonforfeiture values and reserves on the underlying insurance policy, both for active lives and those in long-term care claim status.*

*K. Subsections F and H of this section shall not apply to group insurance policies as defined in subsections A and C of § 38.2-3522.1 of the Code of Virginia where:*

*1. The policies insure 250 or more persons and the policyholder has 5,000 or more eligible employees of a single employer; or*

*2. The policyholder, and not the certificateholders, pays a material portion of the premium, which shall not be less than 20% of the total premium for the group in the calendar year prior to the year a rate increase is filed.*

## **14 VAC 5-200-200. Standard format outline of coverage.**

This section of the chapter implements, interprets and makes specific, the provisions of § 38.2-5207 of the Code of Virginia in prescribing a standard format and the content of an outline of coverage.

1. The outline of coverage shall be a freestanding document in at least 10-point type.

2. The outline of coverage shall contain no material of an advertising nature.

3. Text which is capitalized or underscored in the standard format for outline of coverage may be emphasized by other means which provide prominence equivalent to such capitalization or underscoring.

4. The text and sequence of text of the standard format for outline of coverage is mandatory, unless otherwise specifically indicated.

5. Format for outline of coverage:

[COMPANY NAME]

[ADDRESS--CITY & STATE]

[TELEPHONE NUMBER]

### **LONG-TERM CARE INSURANCE OUTLINE OF COVERAGE**

[Policy Number or Group Master Policy and Certificate Number]

[Except for policies or certificates which are guaranteed issue, the following caution statement, or language substantially similar, must appear as follows in the outline of coverage.]

Caution: The issuance of this long-term care insurance [policy] [certificate] is based upon your responses to the questions on your application. A copy of your [application] [enrollment form] [is enclosed] [was retained by you when you applied.] If your answers are incorrect or untrue, the company has the right to deny benefits or rescind your policy. The best time to clear up any questions is now, before a claim arises. If, for any reason,

any of your answers are incorrect, contact the company at this address: [insert address]

1. This policy is [an individual policy of insurance] ([a group policy] which was issued in the [indicate jurisdiction in which the group policy was issued]).

2. **PURPOSE OF OUTLINE OF COVERAGE.** This outline of coverage provides a very brief description of the important features of the policy. You should compare this outline of coverage to outlines of coverage for other policies available to you. This is not an insurance contract, but only a summary of coverage. Only the individual or group policy contains governing contractual provisions. This means that the policy or group policy sets forth in detail the rights and obligations of both you and the insurance company. Therefore, if you purchase this coverage, or any other coverage, it is important that you **READ YOUR POLICY (OR CERTIFICATE) CAREFULLY!**

3. **TERMS UNDER WHICH THE POLICY OR CERTIFICATE MAY BE RETURNED AND PREMIUM REFUNDED.**

a. [Provide a brief description of the right to return--"free look" provision of the policy.]

b. [Include a statement that the policy either does or does not contain provisions providing for a refund or partial refund of premium upon the death of an insured or surrender of the policy or certificate. If the policy contains such provisions, include a description of them.]

4. **THIS IS NOT MEDICARE SUPPLEMENT COVERAGE.** If you are eligible for Medicare, review the Medicare Supplement Buyer's Guide available from the insurance company.

a. [For agents] Neither [insert company name] nor its agents represent Medicare, the federal government or any state government.

b. [For direct response] [insert company name] is not representing Medicare, the federal government, or any state government.

5. **LONG-TERM CARE COVERAGE.** Policies of this category are designed to provide coverage for one or more necessary or medically necessary diagnostic, preventive, therapeutic, rehabilitative, maintenance, or personal care services, provided in a setting other than an acute care unit of a hospital, such as in a nursing home, in the community or in the home.

This policy provides coverage in the form of a fixed dollar indemnity benefit for covered long-term care expenses, subject to policy [limitations] [waiting periods] and [coinsurance] requirements. [Modify this paragraph if the policy is not an indemnity policy.]

6. **BENEFITS PROVIDED BY THIS POLICY.**

a. [Covered services, related deductible(s) deductible or deductibles, waiting periods, elimination periods and benefit maximums.]

b. [Institutional benefits, by skill level.]



c. [Non-institutional benefits, by skill level.]

[Any benefit screens must be explained in this section. If these screens differ for different benefits, explanation of the screen should accompany each benefit description. If an attending physician or other specified person must certify a certain level of functional dependency in order to be eligible for benefits, this too must be specified. If activities of daily living (ADLs) are used to measure an insured's need for long-term care, then these qualifying criteria or screens must be explained.]

7. LIMITATIONS AND EXCLUSIONS.

[Describe:

- a. Preexisting conditions;
- b. Noneligible facilities/provider;
- c. Noneligible levels of care (e.g., unlicensed providers, care or treatment provided by a family member, etc.);
- d. Exclusions/exceptions;
- e. Limitations.]

[This section should provide a brief specific description of any policy provisions which limit, exclude, restrict, reduce, delay, or in any other manner operate to qualify payment of the benefits described in (6) above.] THIS POLICY MAY NOT COVER ALL THE EXPENSES ASSOCIATED WITH YOUR LONG-TERM CARE NEEDS.

8. RELATIONSHIP OF COST OF CARE AND BENEFITS. Because the costs of long-term care services will likely increase over time, you should consider whether and how the benefits of this plan may be adjusted. [As applicable, indicate the following:

- a. That the benefit level will not increase over time;
- b. Any automatic benefit adjustment provisions;
- c. Whether the insured will be guaranteed the option to buy additional benefits and the basis upon which benefits will be increased over time if not by a specified amount or percentage;
- d. If there is such a guarantee, include whether additional underwriting or health screening will be required, the frequency and amounts of the upgrade options, and any significant restrictions or limitations;
- e. And finally, describe whether there will be any additional premium charge imposed, and how that is to be calculated.]

9. TERMS UNDER WHICH THE POLICY (OR CERTIFICATE) MAY BE CONTINUED IN FORCE OR DISCONTINUED.

[(i) Describe the policy renewability provisions; (ii) For group coverage, specifically describe continuation/conversion provisions applicable to the certificate and group policy; (iii) Describe waiver of premium provisions or state that there are no such provisions (iv) State whether or not the company has a right to change premium, and if such a right

exists, describe clearly and concisely each circumstance under which premium may change.]

10. ALZHEIMER'S DISEASE AND OTHER ORGANIC BRAIN DISORDERS.

[State that the policy provides coverage for insureds clinically diagnosed as having Alzheimer's disease or related degenerative and dementing illnesses. Specifically describe each benefit screen or other policy provision which provides preconditions to the availability of policy benefits for such an insured. In the event that the policy does not cover such preexisting conditions, that information should be included here also.]

11. PREMIUM.

[1. State the total annual premium for the policy;

2. If the premium varies with an applicant's choice among benefit options, indicate the portion of annual premium which corresponds to each benefit option.]

12. ADDITIONAL FEATURES.

- [1. Indicate if medical underwriting is used;
- 2. Describe other important features.]

VA.R. Doc. No. R03-59; Filed October 24, 2002, 11:58 a.m.



TITLE 24. TRANSPORTATION AND MOTOR VEHICLES

COMMONWEALTH TRANSPORTATION BOARD

Title of Regulation: 24 VAC 30-71. Minimum Standards of Entrances to State Highways (amending 24 VAC 30-71-10, 24 VAC 30-71-70, 24 VAC 30-71-80, 24 VAC 30-71-90, 24 VAC 30-71-100, 24 VAC 30-71-110, 24 VAC 30-71-120, 24 VAC 30-71-130, 24 VAC 30-71-150, 24 VAC 30-71-160, and 24 VAC 30-71-170).

Statutory Authority: § 33.1-12, 33.1-197, and 33.1-198 of the Code of Virginia.

Public Hearing Date: December 16, 2002 - 7 p.m.

Public comments may be submitted until January 17, 2003. (See Calendar of Events section for additional information)

Agency Contact: Steve D. Edwards, Transportation Engineer Senior, Mobility Management Division, Department of Transportation, 1100 Bank Street, Richmond, VA 23219, telephone (804) 786-0121, FAX (804) 225-2448 or e-mail Steve.Edwards@VirginiaDOT.org.

Basis: In general terms, § 33.1-12 of the Code of Virginia vests the Commonwealth Transportation Board (CTB) with the powers and duties to regulate traffic operations on systems of state highways not in conflict with the laws of this Commonwealth.

---

# Proposed Regulations

---

Specific statutory authority for promulgating the existing regulation is set forth in §§ 33.1-197 and 33.1-198 of the Code of Virginia, which grant the commissioner the authority to issue permits for connections over shoulders of highways for (i) intersecting private roads and (ii) intersecting commercial establishment entrances.

Given the general authority granted the CTB to make regulations at its discretion, and the specific authority granted the commissioner concerning the issuance of permits, as well as the specific reference to the regulation by title, the General Assembly clearly intended that VDOT have broad control over the types of entrances installed under these statutes. Providing safe ingress and egress for entrance users is a responsibility of the Commonwealth of Virginia and the Department of Transportation. The granting of commercial entrance installations is based on user types, traffic volumes, horizontal and vertical alignments and sight distances, and posted or the 85th percentile operating speeds. VDOT must be able to review permits applied for under this regulation to ensure that deviations are justified from safety and infrastructure integrity standpoints, and the variables mentioned above are taken into account.

Purpose: The rationale for the amendments is to (i) implement public input with which VDOT concurs that is intended to improve the clarity or usefulness of the regulation and (ii) make routine updates to referenced material associated with the regulation.

VDOT believes that such amendments are essential to fulfilling the goals set for the regulation, namely to (i) protect the public's health, safety, and welfare with the least possible cost and intrusiveness to the citizens and businesses of the Commonwealth and (ii) determine whether the regulation is written clearly and understandably.

VDOT is obligated to ensure that the health and safety of VDOT and non-VDOT workers, pedestrians and motorists using the highways of the Commonwealth are preserved. The regulation provides a framework whereby uniform standards are established to control the use of highway rights-of-way when it is necessary to provide access to commercial, private, and industrial properties abutting state roads. These controls not only protect through traffic from indiscriminate interferences, they also promote safe and convenient connections to public highways.

Permits are required when work is performed on or crossing any right-of-way under VDOT's jurisdiction. Permits are also required when modifications are needed for an existing entrance due to a change in the land use, or some other change that causes higher volumes of use. These requirements allow VDOT to ensure that work is performed with due regard to worker and motorist safety, as well as sound civil engineering principles. Therefore, both safety and preservation of the highway infrastructure are maintained.

VDOT believes that the protection of public safety and welfare is enhanced by making the proposed changes, especially since many of them came from the regulated public itself. Officials from Prince William County contributed several suggestions, most of which VDOT agreed to implement. These suggestions dealt primarily with adding to the list of

defined terms, and adding descriptive technical terms (such as roundabouts) when discussing entrance requirements.

For example, modifying definitions to make them consistent with those used by other divisions will eliminate potential confusion. Providing additional information on accessibility to electronic documents associated with the regulation will improve the ease of use, since users can obtain the material more quickly.

Substance: The structure of the regulation has not been affected. The substantive changes deal with updates to the documents associated with the regulation and the revised or additional wording to promote clarity. The wording revisions occur primarily in the "Definitions" section and sections dealing with design issues (such as 24 VAC 30-71-70 and 24 VAC 30-71-100).

Issues: VDOT believes that the nature of the proposed revisions do not impose any disadvantages to the public or the Commonwealth. The changes are intended to provide users with a regulation that is easier to use and understand and, since many of the changes are from public comment, the regulated parties should be satisfied with the results. VDOT will collect additional public input during the amendment process, and determine if additional changes are appropriate prior to final adoption by the CTB.

Fiscal Impact:

A. Projected costs for implementation/enforcement: The proposed revised regulation is not anticipated to impose additional implementation or enforcement costs to the Commonwealth since it is currently being administered as part of daily field operations. It is anticipated that the proposed regulation will cost the Virginia Department of Transportation approximately \$10,000 to amend, print and distribute. No additional personnel will be needed to enforce the proposed amended regulation, since existing staff currently administers the regulation. These employees handle other duties (e.g., land use permit-related tasks, hauling permit-related tasks, reviewing subdivision plans, etc.) as well, so they would still be necessary even if the regulation did not exist. The "Minimum Standards of Entrances to State Highways" refers to forms used for the "Land Use Permit Manual," (24 VAC 30-150), so it has no forms of its own. Instructions for accessing these forms electronically from VDOT's Internet site are included as part of this submission.

The fee structure for entrance permits is included in the "Land Use Permit Manual" (24 VAC 30-150), which is to be revised under the Administrative Process Act. Permit fees vary, depending on the type of work involved; there is a \$40 minimum charge plus whatever additive charges are appropriate. For example, a private entrance permit requiring permit surety would require a \$40 rate. If work on a private, commercial, street or road tie-in, median crossover, or subdivision entrance required more than one opening, an additive charge of \$5 per opening or crossover would be assessed, provided the work was not performed in conjunction with a blanket permit.

Since the proposed revisions to 24 VAC 30-71 do not change the cost of any fees or change the surety bond requirements, it would be premature to discuss the fee structure further at

this time. It is anticipated that the revisions to the "Minimum Standards of Entrances to State Highways" will not affect the number of entrance permits issued - 19,476 entrance permits were issued in 2001. In contrast, 88,528 total land use permits were issued in 2001, which indicates entrance permits constitute a significant share of the entire annual activity.

1. Fund source/fund detail: VDOT's funds come primarily from the Transportation Trust Fund (a nongeneral fund), comprised of the Highway Maintenance and Operating Fund (HMO) and the Transportation Trust Fund (TTF). The HMO is derived from a mixture of state and federal revenue sources (fuel and hauling permit fees, tolls, road taxes, special-purpose federal funds, etc.), and is spent on administrative and support services (such as computer and physical plant services), highway system maintenance, and specialized activities undertaken by other state agencies (Departments of State Police, Rail and Public Transportation, Motor Vehicles, Old Dominion University, etc.). The Transportation Trust Fund is established by statute (§ 33.1-23.03:1 of the Code of Virginia), and is comprised of funds designated by the General Assembly. Revenues from this fund are spent on highways and other transportation modes, and specialized transportation programs and matching funds. For 2001, these funds totaled \$1.2 and 2.0 billion, respectively. The Virginia Transportation Act of 2000 for the first time made an appropriation of approximately \$545 million for highway projects, but this money will not be used in support of the regulation.

2. Budget activity with a cross-reference to program and subprogram: Funding for Land Use permit activities comes from Program #60300, Subprogram #09 (Construction Management).

3. One-time costs/expenditures: Based on typical costs for public hearings by VDOT's Location and Design Division, overall staff and administrative costs for a single public hearing to collect input for this regulation could range from \$1,500 to \$4,000, depending on the number of newspapers used, and the frequency of the ad. Only one public hearing is planned. Ongoing costs include expenses to print copies of the manual, etc. The regulation will be printed in-house, so there will be no outside printing costs.

B. Projected costs of regulation on localities: There should be no direct costs to localities, since they are generally self-insured, and need not secure bonds for work on CTB right-of-way. They also generally do not perform their own installations, so any permit costs would be directly borne by the contractor performing the work. Permit fees would, therefore, constitute part of the administrative costs to perform the installation. Local public works employees use the "Minimum Standards of Entrances to State Highways" as one of many engineering guides in evaluating their own facilities.

C. Description of those affected by regulation: This regulation would affect individuals who wish to install driveways to connect their homes to the highway, business owners, developers, etc., that construct or modify entrances connecting their businesses or subdivisions to the highway. Since there is an approximate one-to-one relationship between the number of permits issued and the affected

parties, there are currently almost 20,000 parties that are affected by the regulation throughout the Commonwealth.

Department of Planning and Budget's Economic Impact Analysis: The Department of Planning and Budget (DPB) has analyzed the economic impact of this proposed regulation in accordance with § 2.2-4007 G of the Administrative Process Act and Executive Order Number 21 (02). Section 2.2-4007 G requires that such economic impact analyses include, but need not be limited to, the projected number of businesses or other entities to whom the regulation would apply, the identity of any localities and types of businesses or other entities particularly affected, the projected number of persons and employment positions to be affected, the projected costs to affected businesses or entities to implement or comply with the regulation, and the impact on the use and value of private property. The analysis presented below represents DPB's best estimate of these economic impacts.

Summary of the proposed regulation. The proposed regulations will update with the most recent versions the technical documents containing standards of entrances to state highways incorporated by reference. The only substantive change among these is allowing the use of superpave mix in the referenced materials. The proposed amendments will also improve the clarity of the regulation by adding and revising definitions, adding explanations, descriptions, and new terms to the current language in a number of places. Among these changes, the clarification that Virginia Department of Transportation (the department) has discretion to modify the details of private subdivision entrance designs may introduce some economic effects.

Estimated economic impact. These regulations contain minimum standards of entrances to state highways. The entrance design and construction standards are highly technical and are published in seven different documents amounting to over a thousand pages. The standards in these documents are incorporated in the regulations by reference. The proposed changes will update the referenced material with their most recent versions.<sup>1</sup> In addition to updating these documents, metric sight distances along major roads at intersections with minor roads, crossovers or median openings, and commercial entrances will be provided in a table rather than referencing another technical document as currently done.<sup>2</sup> The department indicates that the most recent version of standards of entrances to state highways are currently enforced and the proposed changes will not have any impact on the implementation of these regulations. In

---

<sup>1</sup> The most recent versions of these documents are the following: Road and Bridge Standards (English measurements), effective February 2001, Location and Design Division; Road and Bridge Standards (metric measurements), effective January 1997, Location and Design Division; Pavement Design Guide for Subdivision and Secondary Roads in Virginia, effective September 2000, Materials Division; Road Design Manual (English and metric measurements), effective July 1998, Location and Design Division; Road and Bridge Specifications (English measurements), effective 2002, Construction Division; Road Bridge Specifications (metric measurements), effective 1997, Construction Division; Chief Engineer's memorandum entitled, "Guidance for Planting in the Clear Zone and Landscaping for VDOT Projects" dated October 31, 2000, Environmental Division.

<sup>2</sup> Currently, metric sight distances are referenced in the 1994 edition of A Policy on Geometric Design of Highways and Streets, published by the American Association of State Highway and Transportation Officials.

---

## Proposed Regulations

---

addition, the department indicates that there are only minor differences between old and new versions of the referenced material, which are generally related to the clarity of the language. Thus, no significant economic impact is expected from implementation of the proposed changes at this time since they are already enforced in practice and most of the changes are not substantive. However, by producing consistency between the referenced standards in the regulation and the standards enforced in practice, most of the proposed regulations are expected to improve the clarity of the regulations and reduce potential confusions the highway entrance permit applicants may encounter.

The department indicates that the only substantive change between the two versions of the referenced documents is allowing the use of "superpave mix" in the most recent pavement design guidelines. It is indicated that the current Marshall mix design is restrictive and does not allow contractors the flexibility to design mixes that facilitate the use of new materials that are functional and more durable than, or at least as durable as, the current materials used in pavements. On the other hand, the superpave mix design is a system or a menu of mix design options that contractors can use to determine the characteristics of components in a mix such as liquid asphalt, binder, or the aggregate that is most appropriate for a given location. It also evaluates placement and performance characteristics such as fatigue, thermal cracking, etc. to develop a durable mix and provide the desired levels of safety and other factors inherent in the design specifications. In short, the permit applicants can choose a pavement mix that is appropriate for the location taking into factors such as traffic volume, percentage of trucks, climate, and geography. According to the agency, the superpave mix design resulted from a five-year research project sponsored by the Federal Highway Administration. The study evaluated asphalt performance to determine if improvements in traditional methods could be developed.

The proposed change to allow the use of superpave mix on highway entrances is expected to benefit permit applicants. The applicants will be afforded an option to use the superpave mix design in addition to current designs available to them. They are likely to opt to use this option only if it produces net benefits. It costs about \$1,250 to build a typical private entrance using regular pavement while it costs about \$1,350 if the superpave mix is used.<sup>3</sup> Cost savings from increased durability such as savings in premature repair or replacement costs over the life of the entrance are expected to outweigh the higher costs of superpave to some degree. Thus, if the use of superpave mix is cost efficient for applicants, contractors are likely to inform their customers, and the customers are likely to take advantage of this new option. Although the increased flexibility in choosing pavement design for applicants has the potential to increase monitoring costs to ensure that the performance standards for pavement are met, the department believes that current monitoring practices will be sufficient to ensure compliance with the required standards. The size of aggregate benefits from being able to utilize the superpave option depends on the total number of cases. The department has ongoing efforts to publicize the

superpave concept to municipalities, contractors, developers and other interested parties, but does not know in how many cases the superpave option may be selected.

Most of the other proposed changes are related to the regulatory language and include updating the reference to the Code of Virginia to take into account most recent code changes, adding a new definition, revision of two definitions, and adding explanations, descriptions, or new terms to the current language in a number of places to improve the clarity, and providing additional information on where to obtain electronic and print copies of referenced documents. Similar to most referenced materials, the department indicates that most of these changes will not affect the way these regulations are currently implemented, but mainly clarify the rules contained in them. Thus, no significant economic effects are expected from most of the changes other than reducing the chance for potential confusions.

However, one of the changes under this category may be significant. The change is related to a recent disagreement between the department and an entrance permit applicant. The disagreement was over the discretion of the engineer representing the department, when based on sound engineering principles, to modify the details of the generic private subdivision road/street entrance design included in the regulations. The engineer's discretion is noted in the other 14 design illustrations in the regulation, but not in the private subdivision design illustration. The applicant argued before the court that the engineer did not have the discretion to change the size of the design specified in the regulations because the engineer's discretion was not noted. The court determined that the engineer had authority to amend the details shown only for those illustrations explicitly bearing the provision. Since the proposed change will add a provision to indicate that the engineer can modify the design, the chances of having to approve unsafe sight distance and road geometry configurations which may lead to increased likelihood of crashes, injuries, and deaths will likely be lower. This proposed change is also likely to benefit the department by reducing the chances of having a dispute with an entry permit applicant and consequently reducing potential litigation costs. The entrance applicants on the other hand may incur some additional costs because of required modifications to the designs, or because they may not be able to obtain a permit if site conditions do not allow required modifications for safe entrances.

Businesses and entities affected. The proposed regulations apply to permit applicants who wish to construct a connection to a public highway. The permit applicants may include residential and commercial developers, business owners constructing or modifying their facilities, private homeowners installing driveways, and municipalities. The number of permits issued is positively related to the level of economic activity. For example, during economic expansions more homes and commercial/industrial facilities are built and more permit applications are received to connect them to the state highways. Although variability is inherent in the number of affected entities due to the level of economic activity, the department issued 3,025 highway entrance permits in the last year, which is the best available estimate at this time for the number of affected entities.

---

<sup>3</sup> Source: Virginia Department of Transportation.

Localities particularly affected. The proposed regulations apply to all localities throughout Virginia.

Projected impact on employment. No significant impact on employment is expected.

Effects on the use and value of private property. The proposed option to use superpave mix has the potential to positively contribute relatively small amounts to the value of private homes and commercial/industrial facilities if durability of the connection to state highways is improved. Increase in value should approximately reflect the expected cost savings from reduced repair and maintenance over the life of the pavement minus additional construction costs.

Similarly, modified designs by engineers may improve the safety of an entrance to a state highway. In these cases, the value of the affected property is expected to reflect the discounted value of the reduced likelihood of accidents the owner may involve less the additional costs that must be incurred to comply with the approved design.

Agency's Response to the Department of Planning and Budget's Economic Impact Analysis: The Virginia Department of Transportation concurs with the economic impact analysis prepared by the Department of Planning and Budget.

#### Summary:

*The proposed amendments update the technical documents containing standards of entrances to state highways incorporated by reference with the most recent versions. The only substantive change among these is allowing the use of superpave mix in the referenced materials. The proposed amendments improve the clarity of the regulation by adding and revising definitions, adding explanations, descriptions, and new terms to the current language in a number of places; and clarify that the Virginia Department of Transportation has discretion to modify the details of private subdivision entrance designs.*

#### 24 VAC 30-71-10. Definitions.

The following words and terms when used in this chapter shall have the following meanings unless the content clearly indicates otherwise:

*"Accessible route"* means a continuous unobstructed, stable, firm and slip-resistant path connecting all accessible elements of a facility (may include parking access aisles, curb ramps, crosswalks at vehicular ways, walks, ramps and lifts) that can be approached, entered and used by persons with mobility impairments. An accessible route shall, to the maximum extent feasible, coincide with the route for the general public and shall be a minimum of three feet (0.9 meter) wide.

*"Board"* means the Commonwealth Transportation Board, Commonwealth of Virginia.

*"Central office"* means the office in downtown Richmond that contains the administrative functions, including preconstruction activities, and executes command responsibility and control over all Virginia Department of Transportation activities.

*"Clear zone"* means the unobstructed, relatively flat area provided beyond the edge of the traveled way for the recovery

of errant vehicles. The width of the clear zone is influenced by the type of facility, traffic volume, speed, horizontal alignment and embankment and is detailed in the department's Road Design Manual, English (~~revised October 1996~~) or metric (~~revised September 1996~~) measurement versions (*effective July 1998*).

*"Commercial entrance"* means an entrance serving all entities other than an individual private residence. (See private entrance.)

*"Commissioner"* means the Commonwealth Transportation Commissioner, who is also Vice-Chairman of the Commonwealth Transportation Board.

*"Commonwealth"* means the Commonwealth of Virginia.

*"Crossover" or "median opening"* means a state-maintained area located between opposing traffic, usually paved, to provide for crossing, left turn or U-turn maneuvers, on four- or more lane divided highways.

*"Department"* means the Virginia Department of Transportation (VDOT).

*"Design speed"* means the maximum safe speed that can be maintained over a specified section of highway when conditions are so favorable that the design features of the highway govern, as defined in the American Association of State Highway Transportation Officials' 1994 edition of A Policy on Geometric Design of Highways and Streets.

*"District office"* means the office in each of the nine construction districts located throughout the state that implements the construction and maintenance operations of the Virginia Department of Transportation.

*"Engineer"* means the engineer representing the Virginia Department of Transportation.

*"Operating speed"* means the highest overall speed at which a driver can travel on a given highway under favorable weather conditions and under prevailing traffic conditions without at any time exceeding the safe speed as determined by the design speed on a section-by-section basis, as defined in the American Association of State Highway Transportation Officials' 1994 edition of A Policy on Geometric Design of Highways and Streets.

*"Private entrance"* means an entrance ~~serving an individual that serves up to two private residence residences~~ and is used for the exclusive benefit of the occupant.

*"Private subdivision road or street"* means a road or street that serves more than ~~one two individual property properties~~, is privately owned and maintained, and requires a commercial entrance permit.

*"Right-of-way"* means that property within the entire area of every way or place of whatever nature within the system of state highways under the ownership, control or jurisdiction of the board, ~~which that is open or which that is to be open~~ within the future for the use of the public for purposes of travel in the Commonwealth. The area set out above includes not only the traveled portion but the entire area inside and outside the traveled portion, from boundary line to boundary line, and also

---

# Proposed Regulations

---

parking and recreation areas ~~which~~ *that* are under the ownership, control or jurisdiction of the board.

"*Sight distance*" means, for crossovers and commercial entrances, the distance measured between the height of the driver's eye (3.5 feet) (1.07 meter) and the height of a 4.25-foot (1.30 meter) object without horizontal or vertical obstruction to the line of sight.

"*System of state highways*" means all highways and roads under the ownership, control, or jurisdiction of the board including, but not limited to, the primary, secondary, and interstate systems.

## **24 VAC 30-71-70. Location.**

To prevent undue interference with free traffic movements, entrance locations shall be avoided within ~~intersectional~~ *functional intersection* areas, traffic circles or *roundabouts*, railroad grade crossings, interchanges or similar areas of traffic congestion. It is essential that designs allow unimpeded traffic movements entering or exiting. Parking and storage spaces shall be located a reasonable distance from the entrance location to prevent interference with vehicles attempting to enter or exit the facility.

To reduce the number of points of access to state highways, joint use entrances are recommended if agreement can be reached by the owners. For a joint use entrance to be approved by the department, a copy of the property owner's recorded agreement shall be submitted to the department.

## **24 VAC 30-71-80. Construction.**

The type and depth of pavement shall be clearly indicated on the permit application. The pavement of entrances, turn lanes, and tapers shall be of stable material ~~which~~ *that* is at least comparable to the pavement of the adjacent roadway.

On-site parking shall be designed so as not to interfere with sight distance and to prevent vehicular overhang on state right-of-way. Interior curbing should be set a minimum of two feet (0.61 meter) outside or beyond the right-of-way line and should extend the entire length of the parking area. When parking areas abut curbing sections with sidewalk, parked vehicles shall be kept a sufficient distance from the curbing by the use of parking bumpers, or other means, to prevent vehicle overhang over the sidewalk. The engineer shall determine the need for additional curbing along the right-of-way to the adjacent property line.

Mountable curb (standard CG-3 or CG-7 in the English (~~revised April 1995 effective February 2001~~) or metric (~~revised September effective January 1997~~) measurement versions of the Road and Bridge Standards, Volumes I and II) is required when constructed within the clear zone of a road posted for a speed limit greater than 40 miles per hour (60 kilometers per hour) in rural areas and 45 miles per hour (70 kilometers per hour) in urban and suburban areas. However, mountable curb is not recommended adjacent to sidewalks, *due to potential encroachment of a vehicle onto the sidewalk*.

All curbing and entrance gutters used to construct commercial entrances shall be installed in accordance with the Virginia Department of Transportation's Road and Bridge Standards, English (~~revised April 1995 effective February 2001~~) or metric

(~~revised September effective January 1997~~) measurement versions, and all material shall meet the department's certification.

The property owner or developer of commercial or industrial entrances or subdivision road entrances shall be responsible for the entire construction of the entrance in accordance with the provisions of the required permit.

## **24 VAC 30-71-90. Drainage.**

Entrances shall be constructed so as not to impair drainage within the state's right-of-way, and so that surface water shall drain from the state roadway.

Where deemed necessary by the engineer, copies of a complete drainage layout, based on a drainage study by a qualified engineer, shall be furnished by the permittee, along with his plans. This layout shall include the ultimate development and clearly show how the permittee proposes to handle the drainage and run-off from his development.

Pipe ends *of culverts* shall be reviewed independently by the engineer and grading or treatment at pipe ends shall be done in such a manner as to minimize any hazard the pipe ~~and~~ *ends or structures* may present to an out-of-control vehicle.

## **24 VAC 30-71-100. Crossovers or median openings.**

Crossovers *or median openings* between the main through lanes shall not be permitted at entrances being constructed under provisions of a permit unless determined necessary by the department, and then only in accordance with the current policy on crossovers *or median openings* as outlined in this chapter and the department's Road Design Manual, English (~~revised October 1996~~) or metric (~~revised September 1996~~) measurement versions (*effective July 1998*). All crossover *or median opening* locations shall be approved by the district traffic engineer.

Crossovers *or median openings* that do not meet the standards as outlined in the department's Road Design Manual, English (~~revised October 1996~~) or metric (~~revised September 1996~~) measurement versions (*effective July 1998*), shall be reviewed by the state traffic engineer and the state location and design engineer.

If the department determines that a crossover *or median opening* is permissible, the permittee shall be responsible for the entire cost and construction, including turn lanes, *traffic signal system, or both*, as deemed necessary by the engineer.

## **24 VAC 30-71-110. Auxiliary lanes, right turn lanes and left turn lanes.**

The need for auxiliary lanes, right turn lanes and left turn lanes shall be jointly determined by the district traffic engineer and resident engineer in accordance with the department's latest design and construction criteria included in the English (~~revised October 1996~~) or metric (~~revised September 1996~~) measurement versions (*effective July 1998*) of the Road Design Manual.

**24 VAC 30-71-120. Curb ramps for persons with mobility impairments.**

Ramps in curb sections to aid the physically handicapped shall be provided as required in § ~~45-1-384~~ 15.1-2021 of the Code of Virginia. ~~A~~ The standard drawing of the for depressed curb ramp (CG-12) is as shown in the Road and Bridge Standards, English (~~revised April 1995 effective February 2001~~) or metric (~~September effective January 1997~~) measurement versions, shall be utilized in the design.

**24 VAC 30-71-130. Sight distances.**

The following shall be utilized to evaluate sight distance. Vertical sight distance shall be determined from a target mounted 4.25 feet (1.30 meters) above the grade of the vehicle path simulating a vehicle ~~entering or exiting the entrance~~ traveling the through lanes of the roadway. The sight distance shall be measured from an eye height of 3.5 feet (1.07 meters) to the target. Horizontal sight distance shall be determined from an eye height of 3.5 feet (1.07 meters) with the object being 4.25 feet (1.30 meters). ~~For more information on sight distance, see the 1994 edition of A Policy on Geometric Design of Highways and Streets published by the~~

~~American Association of State Highway Transportation Officials.~~

On a typical two lane road with a horizontal curve, numerous objects restrict sight distance. These include, but are not limited to, cut slopes, buildings, vegetation, and vehicles. Landscaping in these areas shall conform to the Chief Engineer's memorandum entitled "Guidance for Planting in the Clear Zone and Landscaping for VDOT Projects" dated October 31, 2000, pending completion of an updated VDOT Environmental Division's Planting Guidelines Manual, ~~effective 1990~~. It is possible to have sight distance in the winter and not in the spring or summer due to the growth of vegetation. These obstructions should be considered when reviewing a commercial entrance permit. A divided highway may have similar problems. It is important to obtain the desirable commercial entrance sight distance from the entrance as well as the left turn position into the entrance. Any waiver of the required sight distance may only be granted by the chief engineer or the assistant commissioner for operations after a traffic engineering investigation has been conducted.

Table 1 shows specific information about sight distances and speeds along major roads:

Table 1

Sight Distances Along Major Roads at Intersections with Minor Road and Roads, Crossovers or Median Openings, and Commercial Entrances  
(English measurements)

Height of Eye (3.5 ft.)	Height of Object (4.25 ft.)						
	25 mph	30 mph	35 mph	40 mph	45 mph	50 mph	55 mph
Speed Limit* Miles per hour (mph)							
Two and Three Lane Road or Four Lane Divided Highways not at Crossovers	250 ft.	300 ft.	350 ft.	400 ft.	450 ft.	500 ft.	550 ft.
Four Lane** Undivided and Four Lane Divided Highways at Crossovers	300 ft.	350 ft.	425 ft.	475 ft.	525 ft.	600 ft.	650 ft.

Sight Distances Along Major Roads at Intersections with Minor Roads, Crossovers or Median Openings, and Commercial Entrances  
(Metric Measurements)

Height of Eye (1.07 m.)	Height of Object (1.30 m.)					
	40	50	60	70	80	90
Design speed (km/h)*						
Two Lane Major Road	75 m.	95 m.	115 m.	135 m.	150 m.	170 m.
Four Lane Major Road	85 m.	110 m.	130 m.	150 m.	175 m.	195 m.
Four Lane Major Road** (Divided – 5.4 m. Median)	95 m.	115 m.	140 m.	165 m.	185 m.	210 m.

\* Where the operating speed on the respective segment of highway is determined to be lower than the legal speed limit, and, in the judgment of the engineers, the operating speed shall not create hazards for either a driver at a connection or on the major roadway and the legal speed limit cannot and, in all probability, shall not be obtained in the foreseeable future as a result of improvement or reconstruction, the sight distance requirements for the operating speed may then be applied. The operating speed shall be determined by a traffic engineering study at the location in question. In all cases when the operating speed is used in lieu of the speed limit, full documentation of its determination shall be attached to the permit assembly.

\*\* For median widths greater than 60 feet (18 meters), each roadway can be considered as a separate two, three, or four lane roadway. (See the 1994 edition of A Policy on Geometric Design of Highways and Streets.)

---

# Proposed Regulations

---

## **24 VAC 30-71-150. Developer participation in traffic signal cost.**

The following guidelines have been developed in an effort to obtain an equitable method of determining developer responsibility for participation in funding traffic signal work necessitated by land development:

1. Where the proposed development will generate sufficient traffic to warrant signalization, the total cost for design, materials, timing plans, and installation shall be borne by the developer.
2. Where development-generated traffic and existing highway traffic must be combined to meet the requirements for either the major or minor movements for any hour or hours, the developer shall bear 50% of the total cost for design materials, timing plans, and installation.
3. Where an existing traffic signal must be modified to accommodate traffic movements to or from the development, the developer shall bear the total cost for any design, materials, timing plans, installation, and relocation required to accommodate the development traffic.

For large developments, such as regional shopping centers and corporate complexes, the department reserves the right to require that the developer design or have designed the traffic signal, including timing plans, and to install or have installed a complete working ~~installation~~ *traffic signal system*. Designs and installations shall be in accordance with the current departmental specifications and standards and shall be approved by the engineer.

## **24 VAC 30-71-160. Commercial/private entrance *design* illustrations.**

*The details set forth in the illustrations contained in this section may be reduced or modified if approved by the district administrator or engineer.*



## COMMERCIAL ENTRANCE DESIGNS ALONG HIGHWAYS WITH SHOULDERS

(English Units)

### SINGLE TWO-WAY ENTRANCE

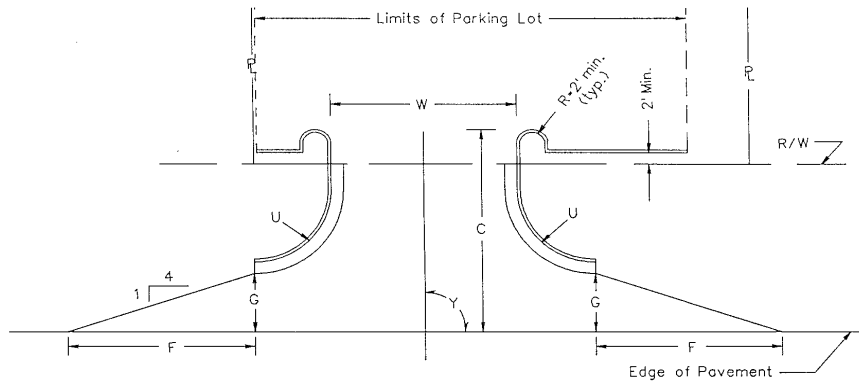

### SINGLE TWO-WAY ENTRANCE WITH RIGHT TURN LANE AND TAPER

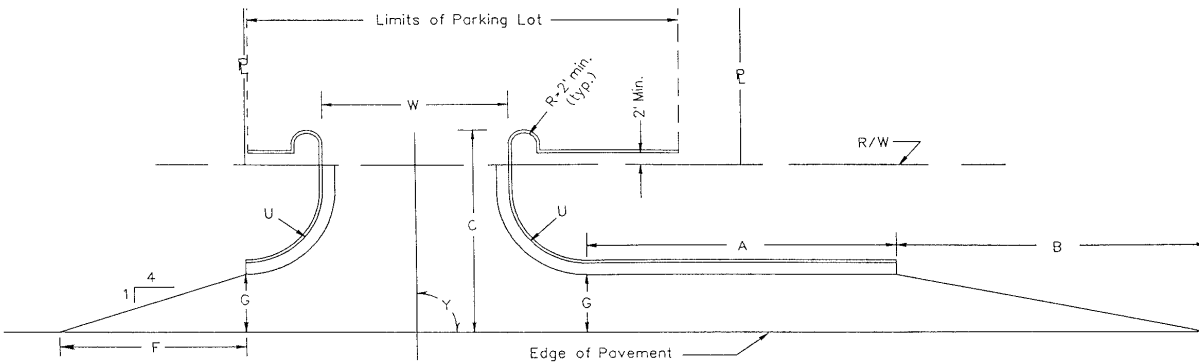

LETTER SYMBOL	DIMENSIONS
A	As determined by the Engineer
B	100' or greater.
C	25' or greater. In developing areas where it is anticipated that the right turn lane will become a continuous thru lane in the future, an additional 12' is recommended.
F	48' or greater.
G	12'
U	12.5' - 50'. The radii selected shall accommodate the anticipated type of vehicle usage. Larger radii should be considered by the designer or may be required by the Engineer if larger vehicles are anticipated; however, in no case shall radii be less than 12.5'.
W	30' - 40'
Y	60° - 90°

Notes:  
Entrance details shown on this sheet may be modified to meet specific site requirements as directed or approved by the Engineer, when based on sound engineering principles.

If an Accessible route as defined in 24 VAC 30-71-10 is present, curb ramps in accordance with St'd. CG-12 will be provided.

# Proposed Regulations

## COMMERCIAL ENTRANCE DESIGNS ALONG HIGHWAYS WITH SHOULDERS

(Metric Units)

### SINGLE TWO-WAY ENTRANCE

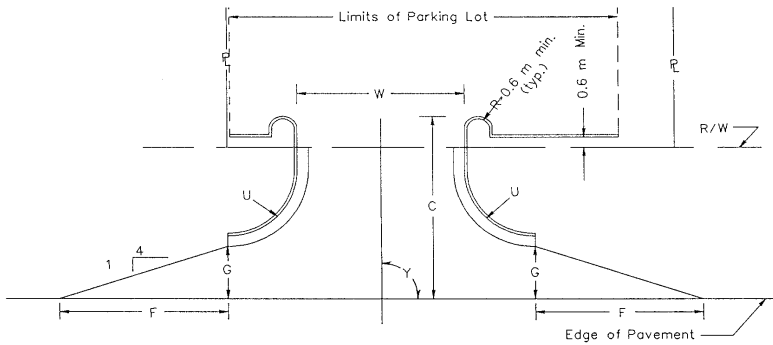

### SINGLE TWO-WAY ENTRANCE WITH RIGHT TURN LANE AND TAPER

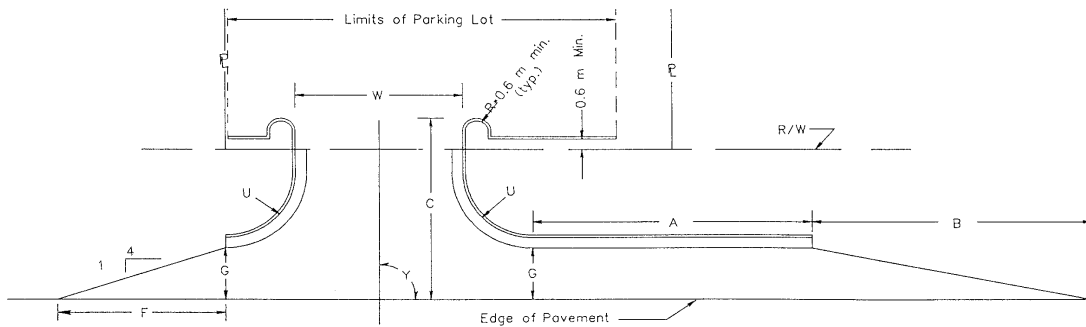

LETTER SYMBOL	DIMENSIONS
A	As determined by the Engineer
B	30 m or greater.
C	7.5 m or greater. In developing areas where it is anticipated that the right turn lane will become a continuous thru lane in the future, an additional 3.6 m is recommended.
F	14.4 m or greater.
G	3.6 m
U	3.8 m - 15 m. The radii selected shall accommodate the anticipated type of vehicle usage. Larger radii should be considered by the designer or may be required by the Engineer if larger vehicles are anticipated; however, in no case shall radius be less than 3.8 m.
W	9 m - 12 m
Y	60° - 90°

Notes:  
Entrance details shown on this sheet may be modified to meet specific site requirements as directed or approved by the Engineer, when based on sound engineering principles.

If an Accessible route as defined in page 24 VAC 30-71-10 is present, curb ramps in accordance with St'd. CG-12 will be provided.

## COMMERCIAL ENTRANCE DESIGNS ALONG HIGHWAYS WITH SHOULDERS

(English Units)

### MULTIPLE ENTRANCES WITH RIGHT TURN LANE AND TAPER

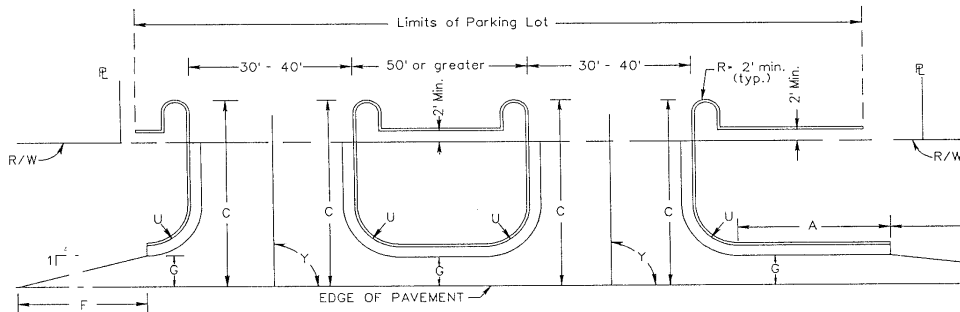

LETTER SYMBOL	DIMENSIONS
A	As determined by the Engineer
B	100' or greater
C	25' or greater, in developing areas where it is anticipated that the right turn lane will become a continuous thru lane in the future, an additional 12' is recommended.
	200' or greater for entrance to a major shopping center as determined by the Engineer.
F	48' or greater.
G	12'
U	4' or greater.
U <sub>1</sub>	12.5' - 50'. The radii selected shall accommodate the anticipated type of vehicle usage. Larger radii should be considered by the Designer or may be required by the Engineer if larger vehicles are anticipated; however, in no case shall the radius be less than 12.5'.
W <sub>1</sub>	14'-20' for one-way traffic
Y	60° - 90°

### SHOPPING CENTER ENTRANCES

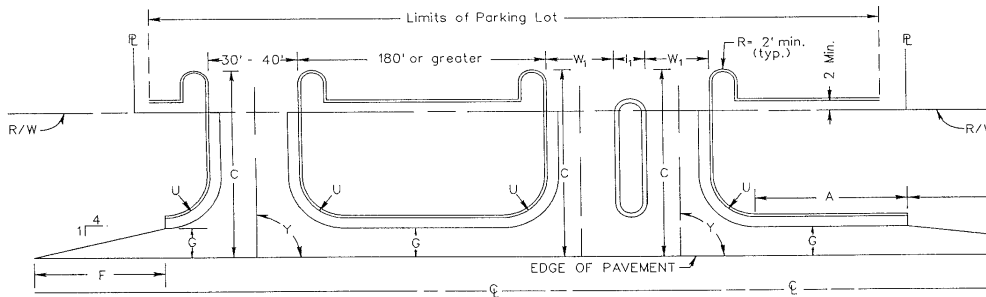

Notes:

Entrance details shown on this sheet may be modified to meet specific site requirements as directed or approved by the Engineer, when based on sound engineering principles.

If an Accessible route as defined in 24 VAC 30-71-10 is present, curb ramps in accordance with Std. CG-12 will be provided.

# Proposed Regulations

## COMMERCIAL ENTRANCE DESIGNS ALONG HIGHWAYS WITH SHOULDERS

(Metric Units)

### MULTIPLE ENTRANCES WITH RIGHT TURN LANE AND TAPER

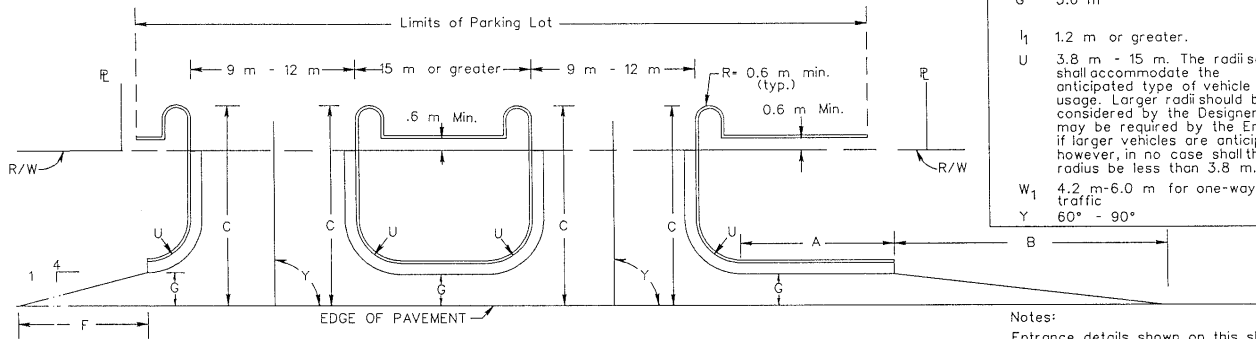

#### LETTER SYMBOL DIMENSIONS

LETTER SYMBOL	DIMENSIONS
A	As determined by the Engineer
B	30 m or greater
C	7.5 m or greater. In developing areas where it is anticipated that the right turn lane will become a continuous thru lane in the future, an additional 3.6 m is recommended.
F	60 m or greater for entrance to a major shopping center as determined by the Engineer.
G	14.4 m or greater.
H	3.6 m
I <sub>1</sub>	1.2 m or greater.
U	3.8 m - 15 m. The radii selected shall accommodate the anticipated type of vehicle usage. Larger radii should be considered by the Designer or may be required by the Engineer if larger vehicles are anticipated; however, in no case shall the radius be less than 3.8 m.
W <sub>1</sub>	4.2 m-6.0 m for one-way traffic
Y	60° - 90°

#### Notes:

Entrance details shown on this sheet may be modified to meet specific site requirements as directed or approved by the Engineer, when based on sound engineering principles.

If an Accessible route as defined in 24 VAC 30-71-10 is present, curb ramps in accordance with Std. CG-12 will be provided.

### SHOPPING CENTER ENTRANCES

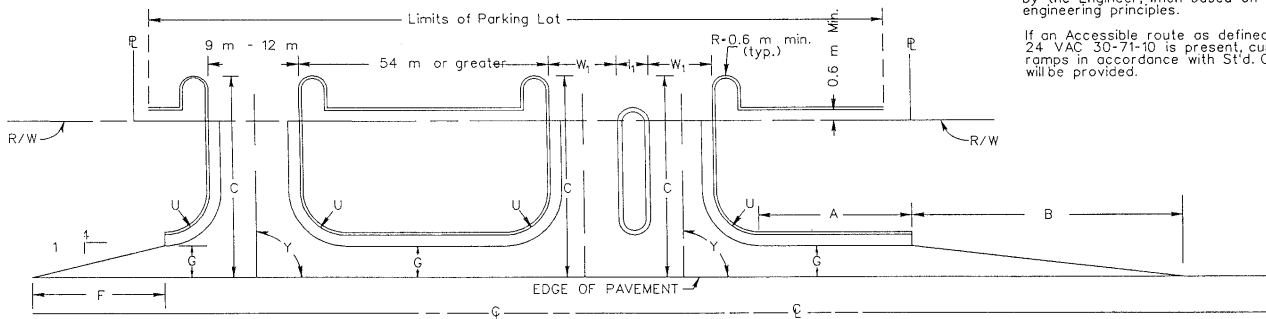

COMMERCIAL ENTRANCE DESIGNS  
ALONG HIGHWAYS WITH SHOULDERS

(English Units)

MULTIPLE ENTRANCES AT INTERSECTIONS

LETTER SYMBOL	DIMENSIONS
A	As determined by the Engineer
B	100' or greater
C	25' or greater. In developing areas where it is anticipated that the right turn lane will become a continuous thru lane in the future, an additional 12' is recommended. 200' or greater for entrance to a major shopping center as determined by the engineer.
E	50' or greater (additional length will be required as directed by the Engineer if intersection is signalized or future signalization is anticipated).
F	48' or greater
G	12'
U	12.5' - 50'. The radii selected shall accommodate the anticipated type of vehicle usage. Larger radii should be considered by the designer or may be required by the Engineer if larger vehicles are anticipated; however, in no case shall the radius be less than 12.5'.
Y	60° - 90°

Notes: Entrance details shown on this sheet may be modified to meet specific site requirements as directed or approved by the Engineer, when based on sound engineering principles.

If an Accessible route as defined in 24 V.A.C. 30-71-10 is present, curb ramps in accordance with St'd. CG-12 will be provided.

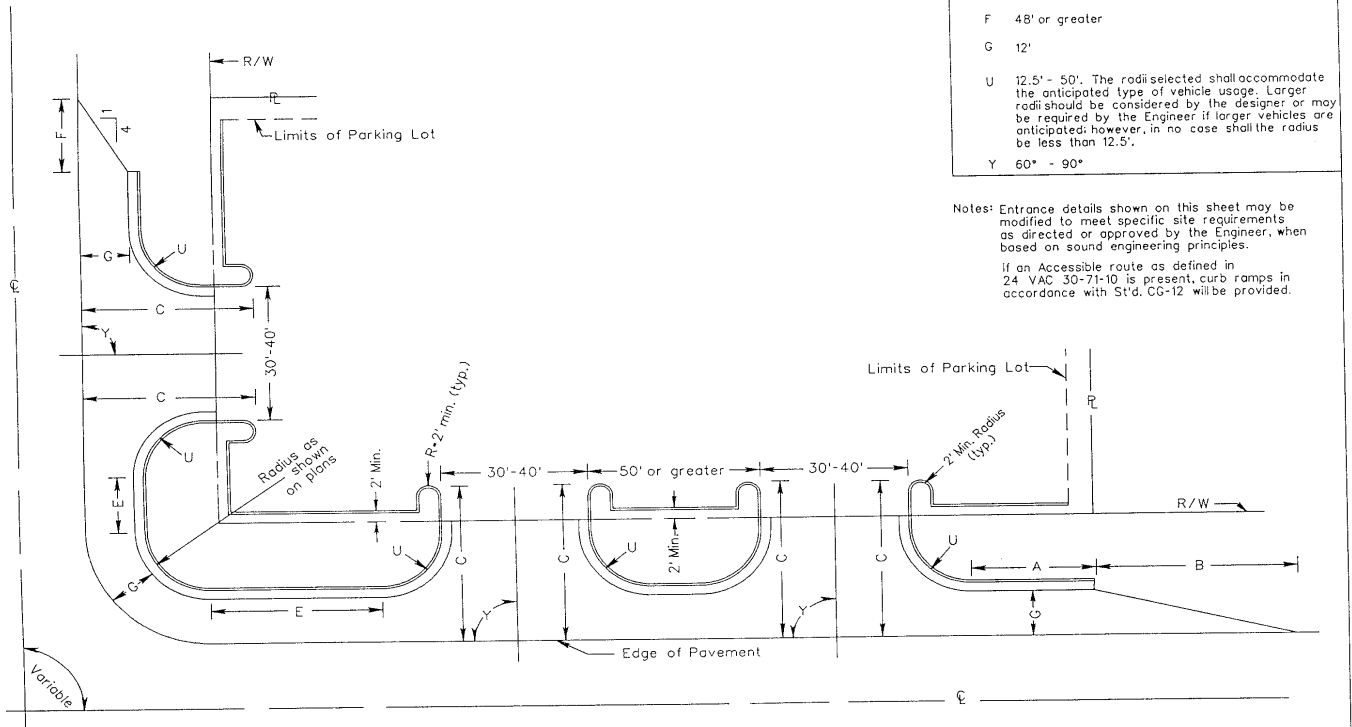

# Proposed Regulations

## COMMERCIAL ENTRANCE DESIGNS ALONG HIGHWAYS WITH SHOULDERS

(Metric Units)

### MULTIPLE ENTRANCES AT INTERSECTIONS

LETTER SYMBOL DIMENSIONS

- A As determined by the Engineer
- B 30 m or greater
- C 7.5 m or greater. In developing areas where it is anticipated that the right turn lane will become a continuous thru lane in the future, an additional 3.6 m is recommended.
- 60 m or greater for entrance to a major shopping center as determined by the engineer.
- E 15 m or greater (additional length will be required as directed by the Engineer if intersection is signalized or future signalization is anticipated).
- F 14.4 m or greater
- G 3.6 m
- U 3.8 m - 15 m. The radii selected shall accommodate the anticipated type of vehicle usage. Larger radii should be considered by the designer or may be required by the Engineer if larger vehicles are anticipated; however, in no case shall the radius be less than 3.8 m.
- Y 60° - 90°

Notes: Entrance details shown on this sheet may be modified to meet specific site requirements as directed or approved by the Engineer, when based on sound engineering principles.

If an Accessible route as defined in 24 VAC 30-71-10 is present, curb ramps in accordance with S't'd. CG-12 will be provided.

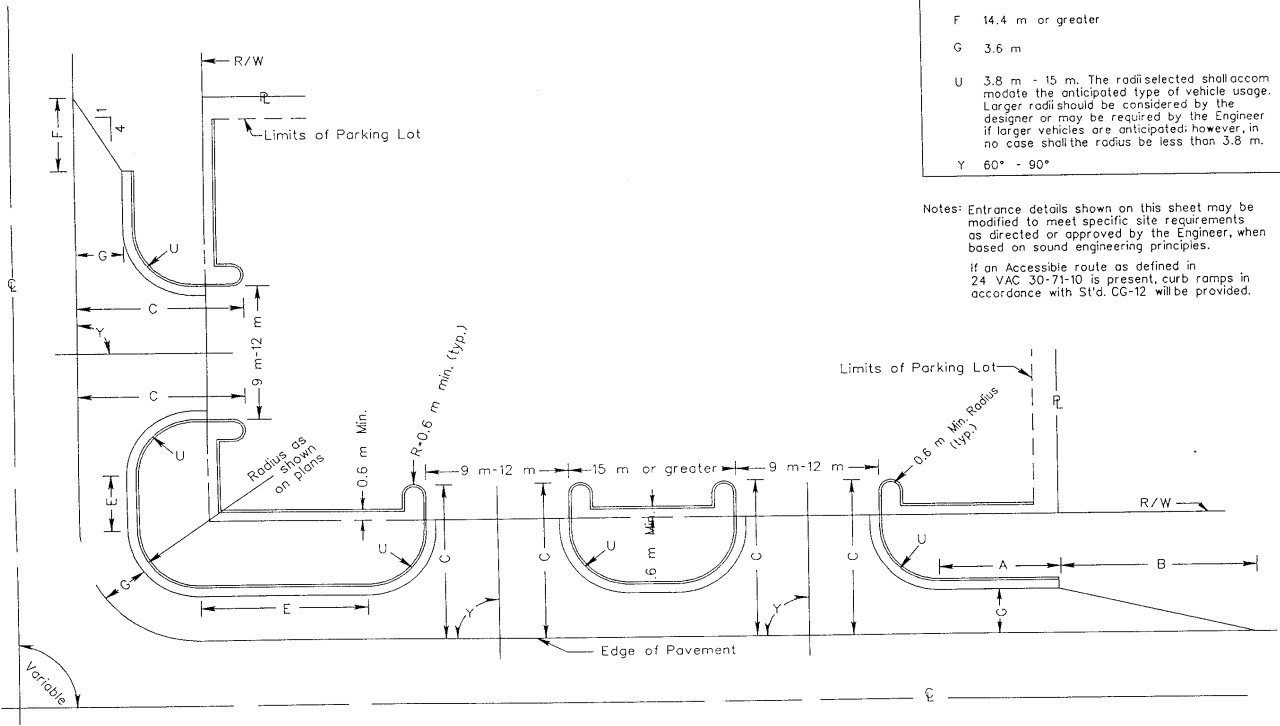

## COMMERCIAL ENTRANCE DESIGNS ALONG HIGHWAYS WITH CURB AND GUTTER

(English Units)

### MULTIPLE ENTRANCES WITH RIGHT TURN LANE AND TAPER

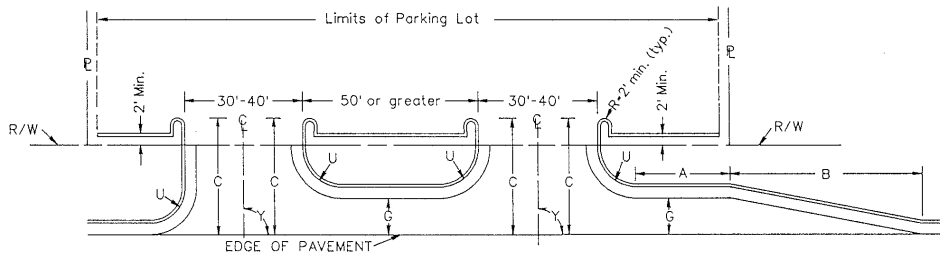

LETTER SYMBOL	DIMENSIONS
A	As determined by the Engineer.
B	100' or greater.
C	25' or greater. In developing areas where it is anticipated that the right turn lane will become a continuous thru lane in the future, an additional 12' is recommended.
	200' or greater for entrance to a major shopping center as determined by the Engineer.
G	12'
U	12.5' to 50'. The radii selected shall accommodate the anticipated type of vehicle usage. Larger radii should be considered by the Designer or may be required by the Engineer if larger vehicles are anticipated; however, in no case shall the radius be less than 12.5'.
W <sub>1</sub>	14'-20' for one-way traffic.
Y	60° - 90°

### TWO ONE-WAY ENTRANCES WITH RIGHT TURN LANE AND TAPER

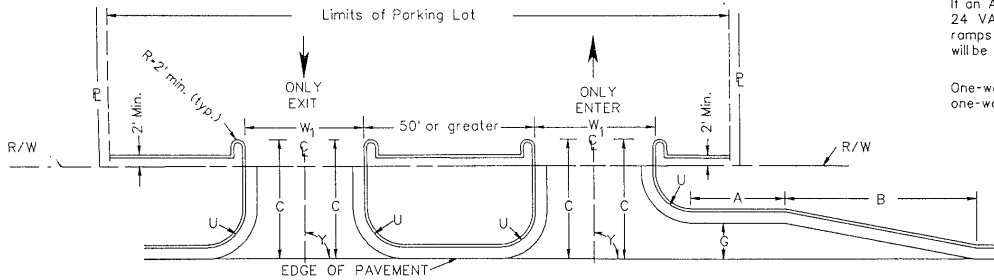

Notes: Entrance details shown on this sheet may be modified to meet specific site requirements as directed or approved by the Engineer, when based on sound engineering principles.

If an Accessible route as defined in 24 VAC 30-71-10 is present, curb ramps in accordance with St'd. CG-12 will be provided.

One-way entrances must be signed one-way.

# Proposed Regulations

## COMMERCIAL ENTRANCE DESIGNS ALONG HIGHWAYS WITH CURB AND GUTTER

(Metric Units)

### MULTIPLE ENTRANCES WITH RIGHT TURN LANE AND TAPER

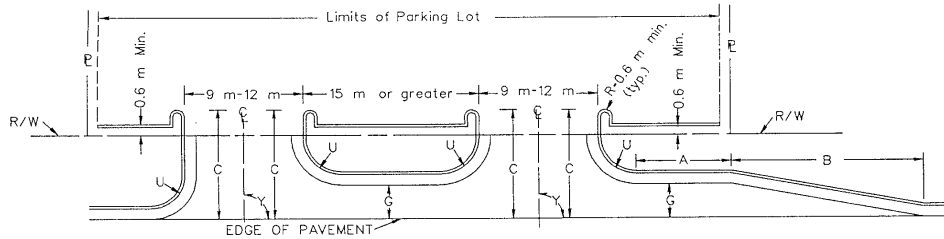

LETTER SYMBOL	DIMENSIONS
A	As determined by the Engineer.
B	30 m or greater.
C	7.5 m or greater. In developing areas where it is anticipated that the right turn lane will become a continuous thru lane in the future, an additional 3.6 m is recommended.
G	10 m or greater for entrance to a major shopping center as determined by the Engineer.
U	3.6 m
U	3.8 m to 15 m. The radii selected shall accommodate the anticipated type of vehicle usage. Larger radii should be considered by the Designer or may be required by the Engineer if larger vehicles are anticipated; however, in no case shall the radius be less than 3.8 m.
W <sub>1</sub>	4.2 m-6.0 m for one-way traffic.
Y	60° - 90°

### TWO ONE-WAY ENTRANCES WITH RIGHT TURN LANE AND TAPER

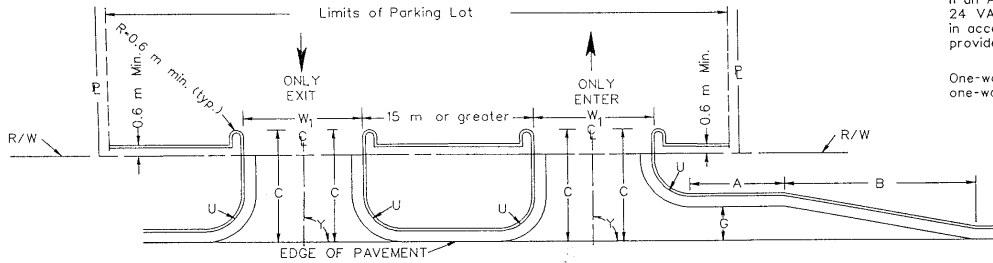

Notes: Entrance details shown on this sheet may be modified to meet specific site requirements as directed or approved by the Engineer, when based on sound engineering principles.

If an Accessible route as defined in 24 VAC 30-71-10 is present, curb ramps in accordance with Std. CG-12 will be provided.

One-way entrances must be signed one-way.



## COMMERCIAL ENTRANCE DESIGNS ALONG HIGHWAYS WITH CURB AND GUTTER

(English Units)

MULTIPLE ENTRANCES WITH RIGHT TURN LANES  
AND TAPER FOR SHOPPING CENTER ENTRANCES

LETTER SYMBOL	DIMENSIONS
A	As determined by the Engineer
B	100' or greater
C	25' or greater. In developing areas where it is anticipated that the right turn lane will become a continuous thru lane in the future, an additional 12' is recommended.
G	12'
I <sub>1</sub>	4' or greater
U	12.5'-50'. The radii selected shall accommodate the anticipated type of vehicle usage. Larger radii should be considered by the designer or may be required by the Engineer if larger vehicles are anticipated; however, in no case shall the radius be less than 12.5'.
W <sub>1</sub>	14'-20' for one-way traffic
Y	60° - 90°

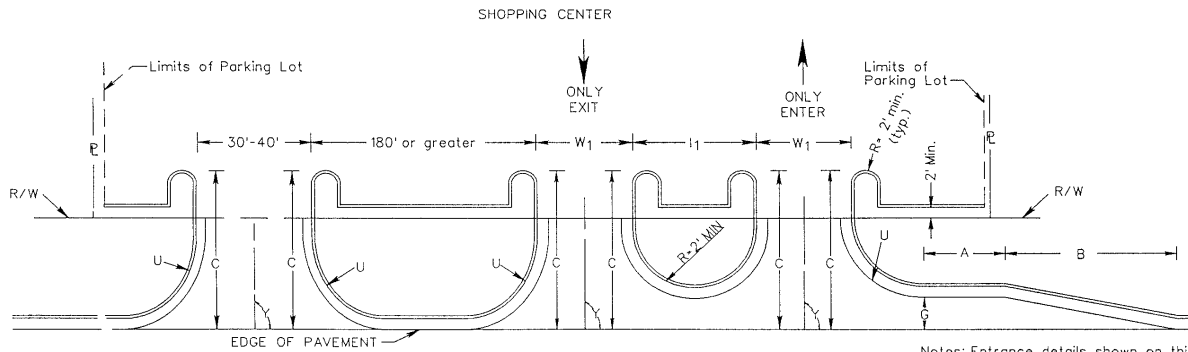

Notes: Entrance details shown on this sheet may be modified to meet specific site requirements as directed or approved by the Engineer, when based on sound engineering principles.

If on Accessible route as defined in 24 VAC 30-71-10 is present, curb ramps in accordance with Std CG-12 will be provided.

One-way entrances must be signed one-way

# Proposed Regulations

## COMMERCIAL ENTRANCE DESIGNS ALONG HIGHWAYS WITH CURB AND GUTTER

(Metric Units)

MULTIPLE ENTRANCES WITH RIGHT TURN LANES  
AND TAPER FOR SHOPPING CENTER ENTRANCES

LETTER SYMBOL	DIMENSIONS
A	As determined by the Engineer
B	30 m or greater
C	7.5 m or greater. In developing areas where it is anticipated that the right turn lane will become a continuous thru lane in the future, an additional 3.6 m is recommended.
	60 m or greater for entrance to a major shopping center as determined by the Engineer.
G	3.6 m
$l_1$	1.2 m or greater
U	3.8 m-15 m. The radii selected shall accommodate the anticipated type of vehicle usage. Larger radii should be considered by the designer or may be required by the Engineer if larger vehicles are anticipated; however, in no case shall the radius be less than 3.8 m.
$W_1$	4.2 m-6.0 m for one-way traffic
Y	60° -90°

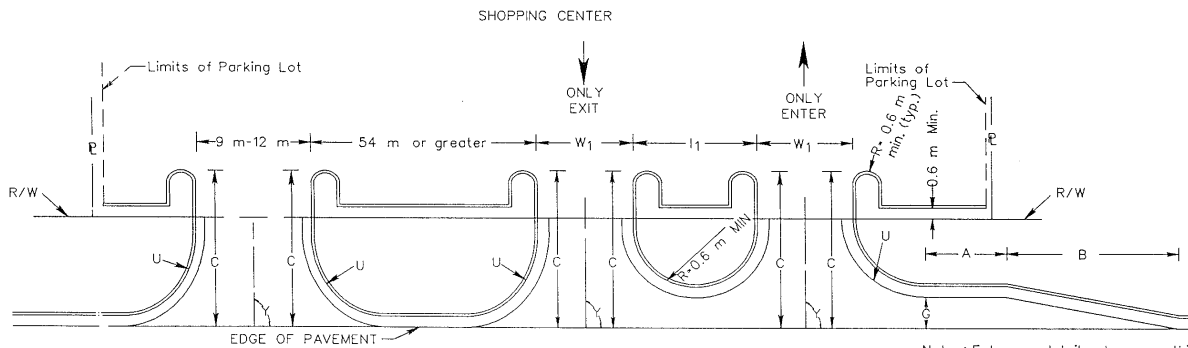

Notes: Entrance details shown on this sheet may be modified to meet specific site requirements as directed or approved by the Engineer, when based on sound engineering principles.

If an Accessible route as defined in 24 VAC 30-71-10 is present, curb ramps in accordance with St'd. CG-12 will be provided.

One-way entrances must be signed one-way

## COMMERCIAL ENTRANCE DESIGNS ALONG HIGHWAYS WITH CURB AND GUTTER

(English Units)

### MULTIPLE ENTRANCES AT INTERSECTION WITH RIGHT TURN LANE AND TAPER

LETTER SYMBOL	DIMENSIONS
A	As determined by the Engineer
B	100' or greater.
C	25' or greater. In developing areas where it is anticipated that the right turn lane will become a continuous thru lane in the future, an additional 12' is recommended.
	200' or greater for entrance to shopping center or other major traffic generator as determined by the engineer.
F	48' or greater.
G	12'
I	50' or greater.
P	50' or greater (additional length will be required as directed by the Engineer if intersection is signalized or future signalization is anticipated.)
U	12.5' - 50'. The radii selected shall accommodate the anticipated type of vehicle usage. Larger radii should be considered by the designer or may be required by the Engineer if larger vehicles are anticipated; however, in no case shall the radius be less than 12.5'.
W	30' - 40'
Y	60° - 90°

Note: Entrance details shown on this sheet may be modified to meet specific site requirements as directed or approved by the Engineer, when based on sound engineering principles.

If an Accessible route as defined in 24 VAC 30-71-10 is present, curb ramps in accordance with St'd. CG-12 will be provided.

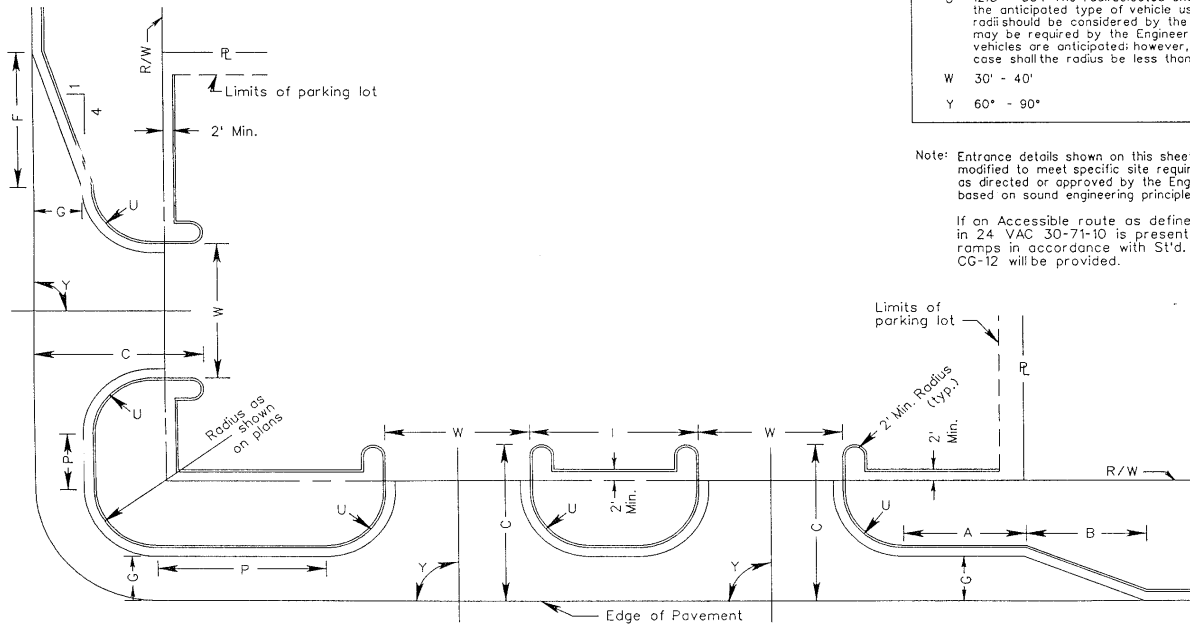

# Proposed Regulations

## COMMERCIAL ENTRANCE DESIGNS ALONG HIGHWAYS WITH CURB AND GUTTER

(Metric Units)

### MULTIPLE ENTRANCES AT INTERSECTION WITH RIGHT TURN LANE AND TAPER

LETTER SYMBOL	DIMENSIONS
---------------	------------

- |   |   |
|---|---|
| A | As determined by the Engineer   |
| B | 30 m or greater.  |
| C | 7.5 m or greater. In developing areas where it is anticipated that the right turn lane will become a continuous thru lane in the future, an additional 3.6 m is recommended.  |
|   | 60 m or greater for entrance to shopping center or other major traffic generator as determined by the engineer.   |
| F | 14.4 m or greater.  |
| G | 3.6 m   |
| i | 15 m or greater.  |
| P | 15 m or greater (additional length will be required as directed by the Engineer if intersection is signalized or future signalization is anticipated.)  |
| U | 3.8 m - 15 m. The radii selected shall accommodate the anticipated type of vehicle usage. Larger radii should be considered by the designer or may be required by the Engineer if larger vehicles are anticipated; however, in no case shall the radius be less than 3.6 m. |
| W | 9 m - 12 m  |
| Y | 60° - 90°   |

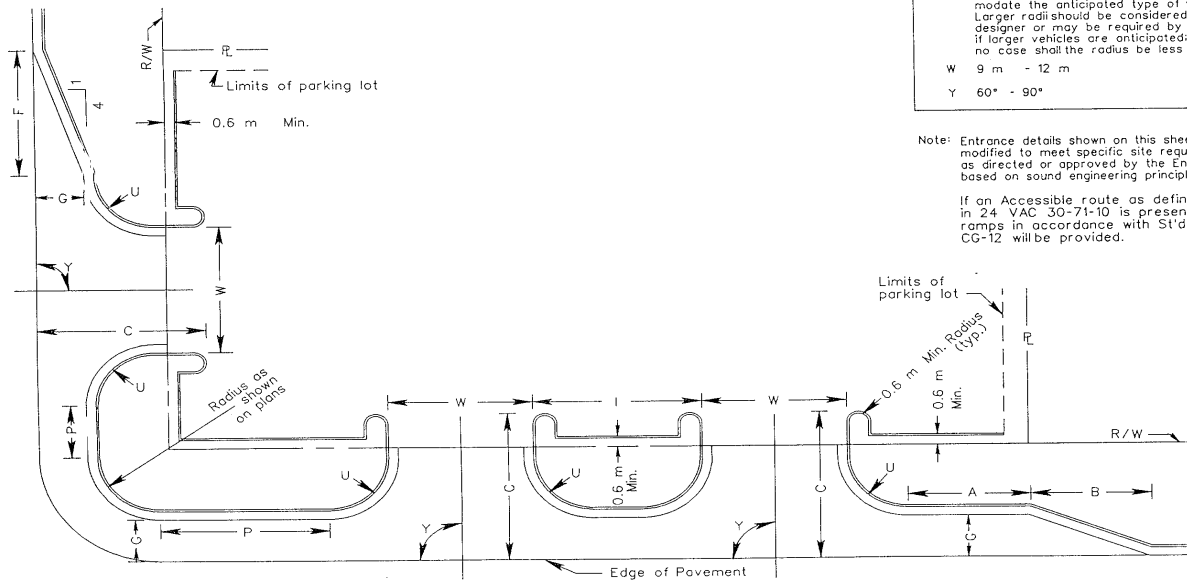

Note: Entrance details shown on this sheet may be modified to meet specific site requirements as directed or approved by the Engineer, when based on sound engineering principles.

If an Accessible route as defined in 24 VAC 30-71-10 is present, curb ramps in accordance with St'd. CG-12 will be provided.

## COMMERCIAL ENTRANCE DESIGNS TO SERVE DRIVE-IN TYPE BUSINESSES SUCH AS DRIVE-IN BANKS, FAST FOOD RESTAURANTS, SERVICE STATIONS, AND CAR WASHES WITH ONE WAY TRAFFIC ENTERING AND/OR EXITING MAJOR HIGHWAY

LETTER SYMBOL	DIMENSIONS
A	As determined by the Engineer
B	100' or greater
C	25' or greater. In developing areas where it is anticipated that the right turn lane will become a continuous thru lane in the future, an additional 12' is recommended.
G	12'
P	50' or greater (additional length will be required as directed by the Engineer if intersection is signalized or future signalization is anticipated.)
U	12.5'-50'. The radiused shall accommodate the anticipated type of vehicle usage. Larger radii should be considered by the Designer or may be required by the Engineer if larger vehicles are anticipated; however, in no case shall radius be less than 12.5'.
W	30'-40'
W <sub>1</sub>	14'-20' for one-way traffic
Y	60° - 90°

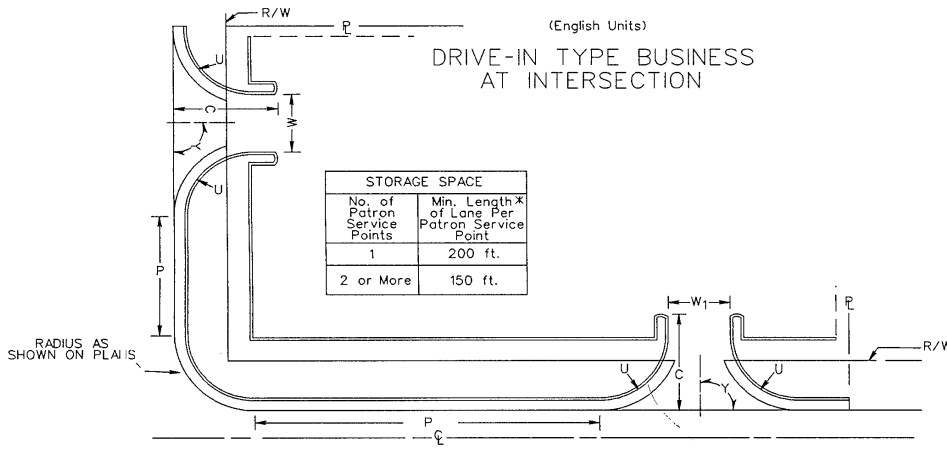

Minimum distance from gasoline pump to R/W line for Service Station	
Pump Island to Pavement Edge	Distance
Parallel	12 ft.
1° to 45°	20 ft.
46° to 90°	30 ft.

### DRIVE-IN TYPE BUSINESS MID BLOCK WITH RIGHT TURN LANE AND TAPER

STORAGE SPACE	
No. of Patron Service Points	Min. Length <sup>x</sup> of Lane Per Patron Service Point
1	200 ft.
2 or More	150 ft.

<sup>x</sup> Length measured from nearest service point to highway.

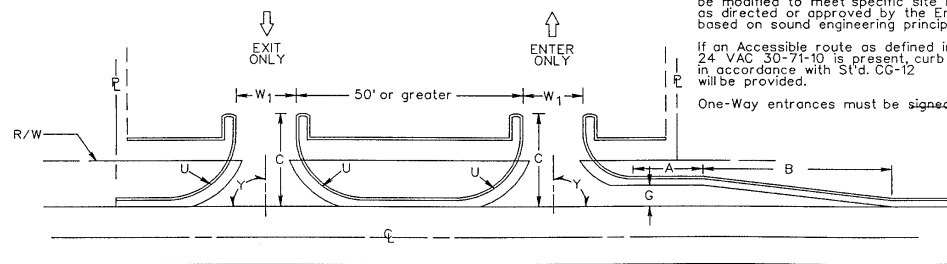

NOTES: Entrance details shown on this sheet may be modified to meet specific site requirements as directed or approved by the Engineer, when based on sound engineering principles.

If an Accessible route as defined in 24 VAC 30-71-10 is present, curb ramps in accordance with Std. CG-12 will be provided.

One-Way entrances must be signed one-way.

# Proposed Regulations

## COMMERCIAL ENTRANCE DESIGNS TO SERVE DRIVE-IN TYPE BUSINESSES SUCH AS DRIVE-IN BANKS, FAST FOOD RESTAURANTS, SERVICE STATIONS, AND CAR WASHES WITH ONE WAY TRAFFIC ENTERING AND/OR EXITING MAJOR HIGHWAY

LETTER SYMBOL	DIMENSIONS
A	As determined by the Engineer
B	30 m or greater
C	7.5 m or greater. In developing areas where it is anticipated that the right turn lane will become a continuous thru lane in the future, an additional 3.6 m is recommended.
G	3.6 m
P	15 m or greater (additional length will be required as directed by the Engineer if intersection is signalized or future signalization is anticipated.)
U	3.8 m-15 m. The radius selected shall accommodate the anticipated type of vehicle usage. Larger radii should be considered by the Designer or may be required by the Engineer if larger vehicles are anticipated; however, in no case shall radius be less than 3.8 m.
W	9 m-12 m
W <sub>1</sub>	4.2 m-6.0 m for one-way traffic
Y	60° - 90°

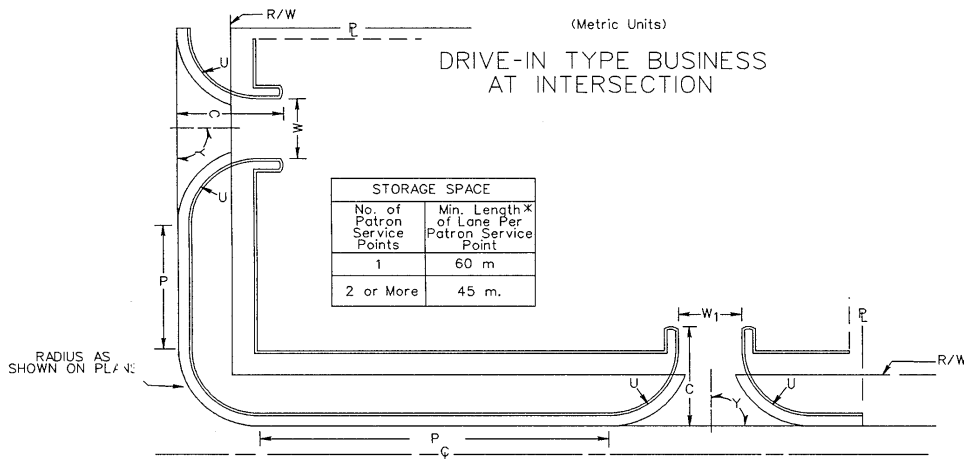

Minimum distance from gasoline pump to R/W line for Service Station	
Pump Island to Pavement Edge	Distance
Parallel	3.6 m
1° to 45°	6 m
46° to 90°	9 m

### DRIVE-IN TYPE BUSINESS MID BLOCK WITH RIGHT TURN LANE AND TAPER

STORAGE SPACE	
No. of Patron Service Points	Min. Length* of Lane Per Patron Service Point
1	60 m
2 or More	45 m.

\*Length measured from nearest service point to highway.

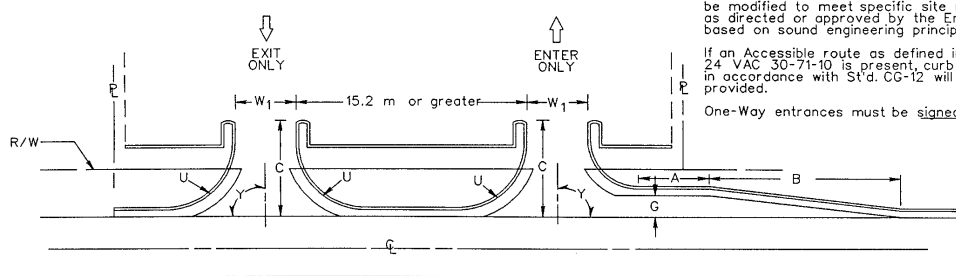

NOTES: Entrance details shown on this sheet may be modified to meet specific site requirements as directed or approved by the Engineer, when based on sound engineering principles.  
If an Accessible route as defined in 24 VAC 30-71-10 is present, curb ramps in accordance with Std. CG-12 will be provided.  
One-Way entrances must be signed one-way.

# STANDARD PRIVATE SUBDIVISION ROAD/STREET ENTRANCE

(English Units)

Note: Entrance details shown on this sheet may be modified to meet specific site requirements as directed or approved by the Engineer, when based on sound engineering principles.

All entrance grades shall start back of the shoulder line. If drainage is necessary, the ditch line may be moved back to provide at least 9" of cover over pipe, as shown at right.

Entrance shall be paved to a minimum width of 24'.

Entrance grades are to be smoothly tied into the roadway by rounding as necessary.

Minimum radius to be 25', increased radius may be required by local ordinance, Resident or District Traffic Engineer.

Entrances in fill to be same as above except location of culvert (when necessary).

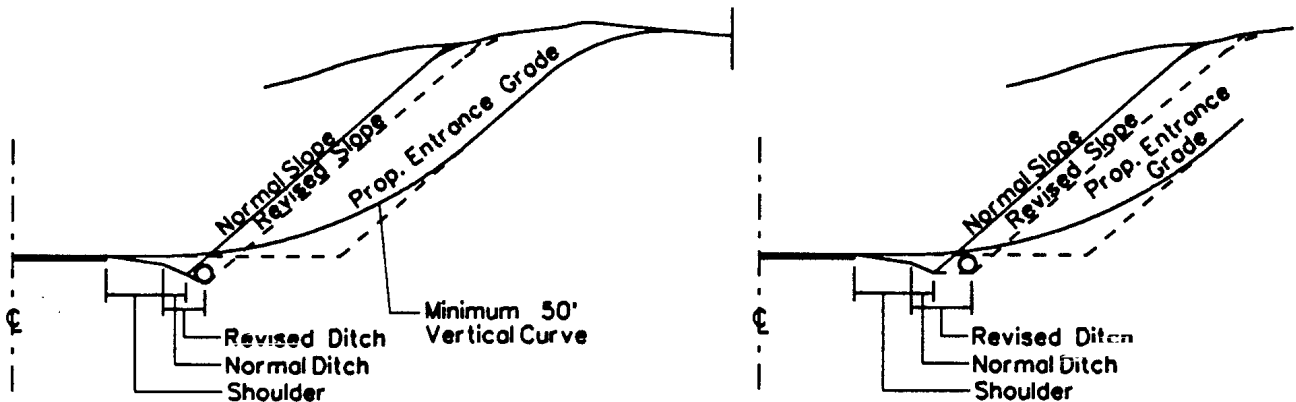
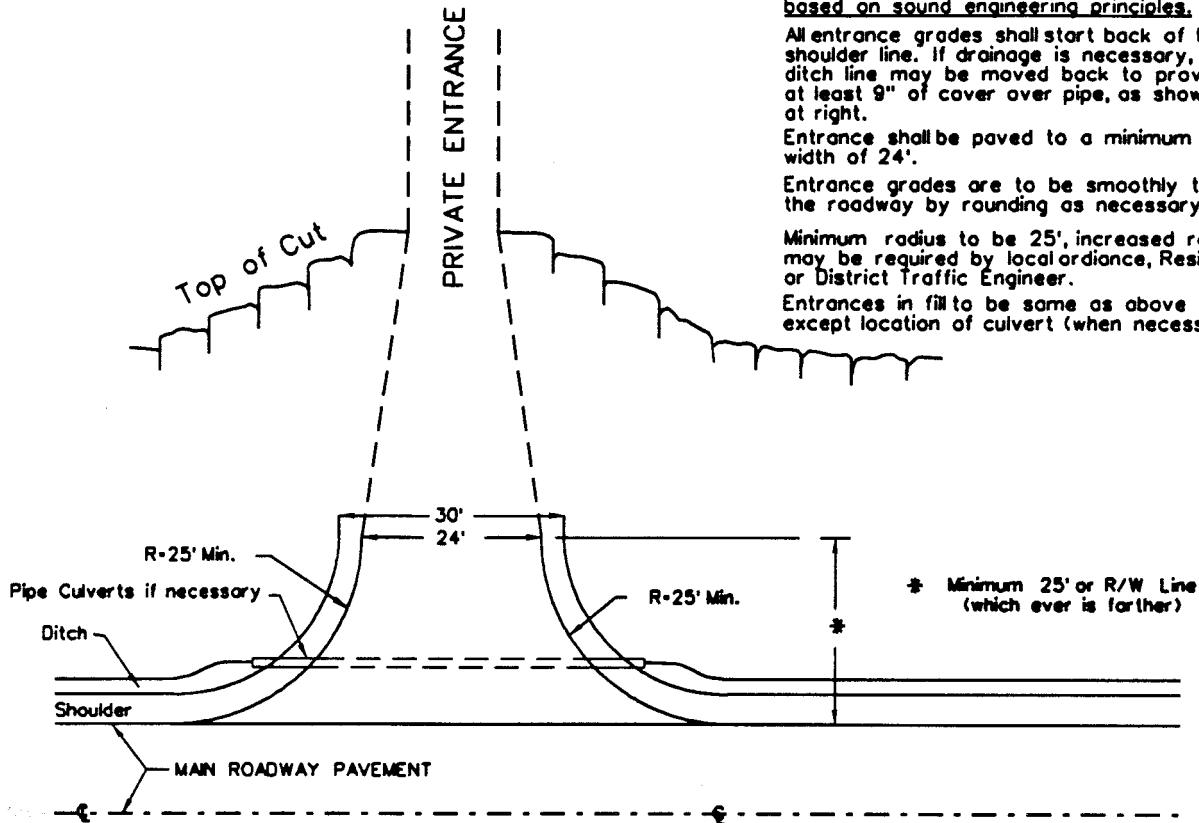

ALTERNATE METHODS FOR PLACING PIPES UNDER ENTRANCES

# STANDARD PRIVATE SUBDIVISION ROAD/STREET ENTRANCE

(Metric Units)

Note: Entrance details shown on this sheet may be modified to meet specific site requirements as directed or approved by the Engineer, when based on sound engineering principles.

All entrance grades shall start back of the shoulder line. If drainage is necessary, the ditch line may be moved back to provide at least 225 mm of cover over pipe, as shown at right.

Entrance shall be paved to a minimum width of 7.2 m.

Entrance grades are to be smoothly tied into the roadway by rounding as necessary.

Minimum radius to be 7.5 m, increased radius may be required by local ordinance, Resident or District Traffic Engineer.

Entrances in fill to be same as above except location of culvert (when necessary).

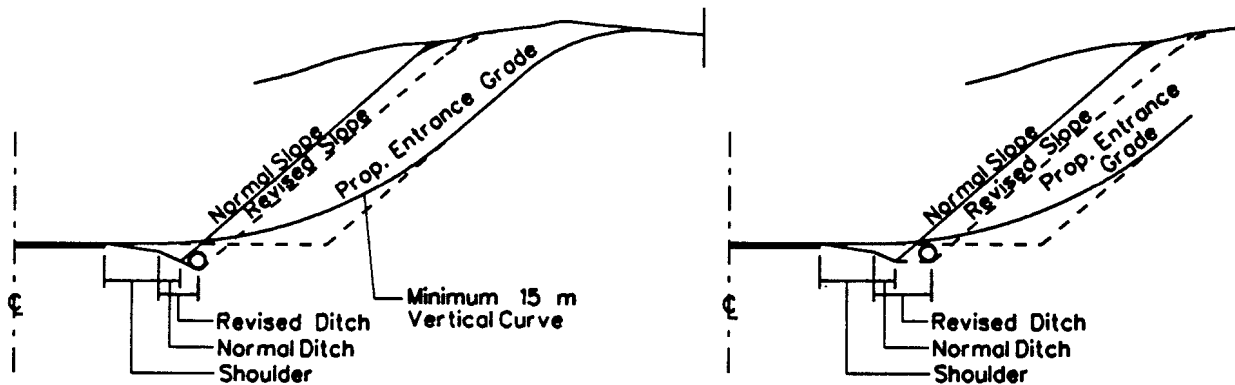
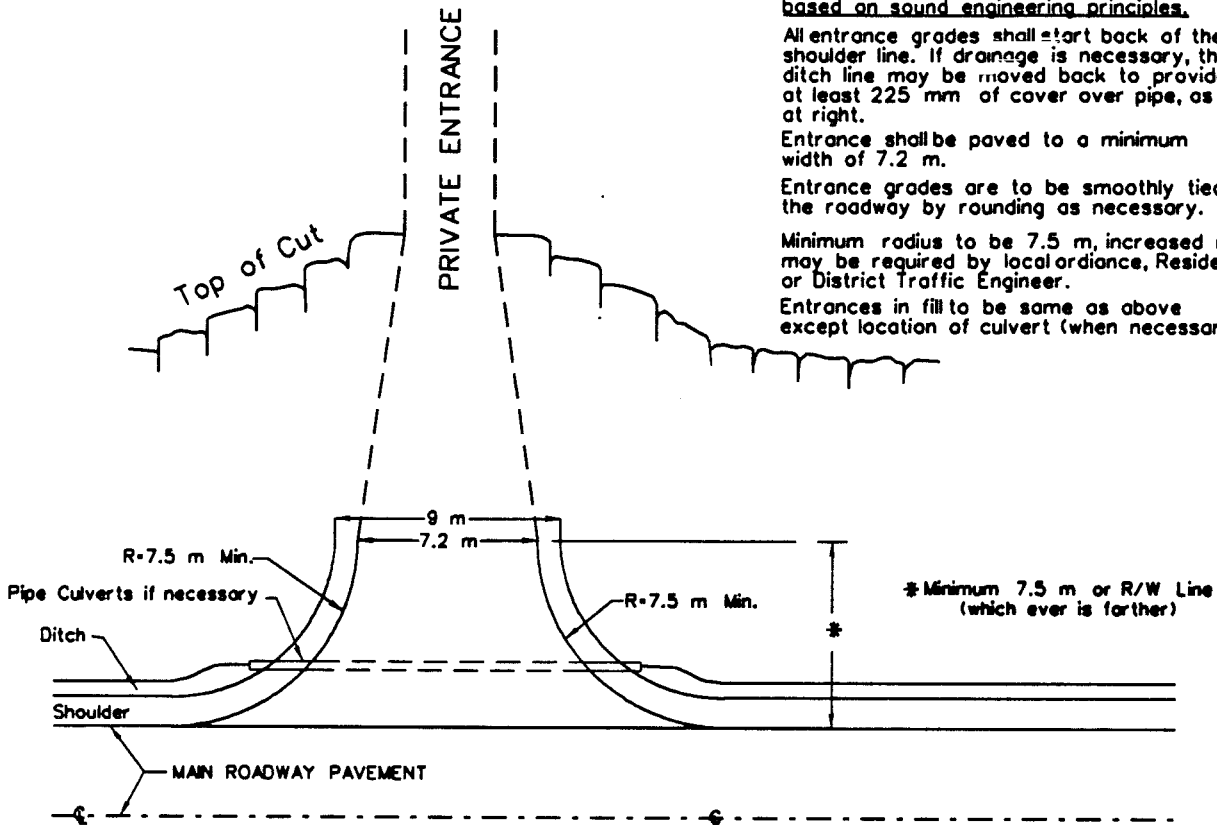

ALTERNATE METHODS FOR PLACING PIPES UNDER ENTRANCES



## **24 VAC 30-71-170. Listing of Documents incorporated by reference.**

~~Information pertaining to the availability and cost of any of these publications should be directed to the department's division indicated, by writing to the Virginia Department of Transportation, 1401 East Broad Street, Richmond, Virginia 23219.~~

- ~~1. Guidelines for Planting along Virginia's Roadways (1990), Environmental Division (VDOT)~~
- ~~2. 24 VAC 30-90-10 et seq., Subdivision Street Requirements (1996), Secondary Roads Division (VDOT)~~
- ~~3. 24 VAC 30-150-10 et seq., Land Use Permit Manual (1983), Maintenance Division (VDOT)~~
- ~~4. A Policy on Geometric Design of Highways and Streets (1994), Location and Design Division (VDOT)~~
- ~~5. Road and Bridge Standards, (revised April 1995) (English measurements), Road and Bridge Standards, (revised September 1997) (metric measurements) Location and Design Division (VDOT)~~
- ~~6. Pavement Design Guide for Subdivision and Secondary Roads in Virginia (revised January 1996), Materials Division (VDOT)~~
- ~~7. Road Design Manual, revised October 1996 (English measurements) Road Design Manual, revised September 1996 (metric measurements), Location and Design Division (VDOT)~~
- ~~8. Road and Bridge Specifications (1994), (English measurements) Road and Bridge Specifications (effective 1997) (metric measurements), Construction Division (VDOT)~~

*A. The document entitled, "A Policy on Geometric Design of Highways and Streets," 1994, American Association of State Highway & Transportation Officials, is incorporated by reference and made a part of this chapter.*

*This document may be obtained from the American Association of State Highway & Transportation Officials, 444 North Capitol Street N.W., Suite 249, Washington, DC 20001; E-mail address: info@aaashto.org.*

*B. The following VDOT documents are incorporated by reference and made a part of this chapter:*

- 1. Chief engineer's memorandum entitled, "Guidance for Planting in the Clear Zone and Landscaping for VDOT Projects" dated October 31, 2000, Environmental Division;*
- 2. Road and Bridge Standards (English measurements), effective February 2001, Location and Design Division;*
- 3. Road and Bridge Standards (metric measurements), effective January 1997, Location and Design Division;*
- 4. Pavement Design Guide for Subdivision and Secondary Roads in Virginia, effective September 2000, Materials Division;*

*5. Road Design Manual (English and metric measurements), effective July 1998, Location and Design Division;*

*6. Road and Bridge Specifications (English measurements), effective 2002, Construction Division;*

*7. Road and Bridge Specifications (metric measurements), effective 1997, Construction Division.*

*The documents identified in this subsection may be obtained by writing to the attention of the division noted by each document at the Virginia Department of Transportation, 1401 E. Broad Street, Richmond, Virginia 23219, or via the Internet at <http://virginiadot.org/business/default.asp>.*

*C. VDOT regulations referenced throughout this chapter may be obtained from the Virginia Department of Transportation, 1401 E. Broad Street, Richmond, Virginia 23219, or by accessing the Virginia Administrative Code website at <http://leg1.state.va.us/000/reg/TOC24030.HTM>.*

<p><b>NOTICE:</b> The forms used in administering 24 VAC 30-71, Minimum Standards of Entrances to State Highways, are listed below. Any amended or added forms are reflected in the listing and are published following the listing.</p>
--

### FORMS

*Entrance Permit Application, MP-253, 1989 (rev. 3/02).*

*Land Use Permit Surety Bond, MP-20 (rev. 4/99).*

# Proposed Regulations

PERMIT APPLICATION  
Rev. 3/2002



Land Use Permit Application No. \_\_\_\_\_  
Commonwealth of Virginia  
Department of Transportation

VDOT RESIDENCY OR PERMIT OFFICE ADDRESS

APPLICATION is hereby made for permit as shown on the accompanying plan or sketch and as described below. Said activity(s) will be done under and in accordance with the rules and regulations of the Commonwealth Transportation Board of Virginia, in so far as said rules are applicable thereto and any agreement between the parties herein before referred to. Where applicable agreements may be attached and made a part of the permit assembly including any cost responsibilities covering work under permit. Applicant agrees to maintain work in a manner as approved upon its completion. Applicant also hereby agrees and is bound and held responsible to the owner for any and all damages to any other installations already in place as a result of work covered by resulting permit. Applicants to whom permits are issued shall at all times indemnify and save harmless the Commonwealth Transportation Board members of the Board, the Commonwealth and all Commonwealth employees, agents, and offices, from responsibility, damage, or liability arising from the exercise of the privileges granted in such permit to the extent allowed by law. In consideration of the issuance of a permit the applicant agrees to waive for itself, successors in interest or assigns any entitlements it may otherwise have or have hereafter under the Uniform Relocation and Assistant Act of 1972 as amended in event the Department or its successor, chooses to exercise its acknowledged right to demand or cause the removal of any or all fixtures, personally of whatever kind or description that may hereafter be located, should this application be approved.

**APPLICANT:**

**TYPE OR PRINT CLEARLY**

Owner Name _____ Address _____ City _____ State _____ ZCode _____ Social Security or Tax ID number _____ Contact Person _____ E-mail Address _____ Phone # ( _____ ) _____ - _____ Fax # ( _____ ) _____ - _____ Emergency (24) Hour Phone Number ( _____ ) _____ - _____	Permit Term Requested _____ Fees Enclosed \$ _____ Check Number _____ Coupons _____ Money Order _____ Other _____ The estimated cost of work to be performed on VDOT Right of Way \$ _____
Agent Name _____ Address _____ City _____ State _____ ZCode _____ Social Security or Tax ID number _____ Contact Person _____ E-mail Address _____ Phone # ( _____ ) _____ - _____ Fax # ( _____ ) _____ - _____ Emergency (24) Hour Phone Number ( _____ ) _____ - _____	<b>Surety Information:</b> Surety Posted by Owner <input type="checkbox"/> or Agent <input type="checkbox"/> Surety Issued By _____ Amount of Surety \$ _____ Obligation Amount \$ _____ Bond # _____ Letter of Credit # _____ Corporate Surety <input type="checkbox"/> Resolution <input type="checkbox"/> Ordinance <input type="checkbox"/> Waived <input type="checkbox"/> Cash Surety <input type="checkbox"/>

**Request Permission:** To perform the following activity(s) \_\_\_\_\_  
 \_\_\_\_\_  
 \_\_\_\_\_  
 \_\_\_\_\_  
 \_\_\_\_\_ as per attached plans.

**Location:** Tax Map Number \_\_\_\_\_ Applicant Job No. \_\_\_\_\_  
 Geographically in County / Town / City of \_\_\_\_\_ On Highway Route and /or Name \_\_\_\_\_  
**Between** Route \_\_\_\_\_ St. Name \_\_\_\_\_ Latitude \_\_\_\_\_ Longitude \_\_\_\_\_  
**And** Route \_\_\_\_\_ St. Name \_\_\_\_\_ Latitude \_\_\_\_\_ Longitude \_\_\_\_\_

**IF APPLICABLE, I AGREE TO PAY THE FULL SALARY AND EXPENSES OF A STATE ASSIGNED INSPECTOR IN CONJUNCTION WITH THIS PROJECT, COVERED BY ACCOUNT RECEIVABLE NUMBER.**

Signature of applicant \_\_\_\_\_ Title \_\_\_\_\_ Date \_\_\_\_\_  
 Signature of agent \_\_\_\_\_ Title \_\_\_\_\_ Date \_\_\_\_\_

All applicable items on this form must be completed before your request can be considered. Recheck information furnished to avoid delay. Prepayment Required - make Remittance payable to Virginia Department of Transportation.

**VDOT USE ONLY**

Receipt is hereby acknowledged of CHECK \_\_\_\_\_, COUPON \_\_\_\_\_, M.O. \_\_\_\_\_, OTHER (Specify) \_\_\_\_\_, In The Amount of \$ \_\_\_\_\_. Permit Fee \$ \_\_\_\_\_, Cash Surety \$ \_\_\_\_\_. VDOT Reference Number \_\_\_\_\_.  
 Signed \_\_\_\_\_ VDOT.

White Copy To Central Office Pink Copy To Permit Office Blue Copy To District office Yellow Copy To Applicant

MP-20  
Rev. 04/99



**Virginia Department of Transportation**  
*Land Use Permit Surety Bond*  
*Maintenance Division*

BE KNOWN THAT WE \_\_\_\_\_ as Principal, and \_\_\_\_\_ a corporation duly incorporated under the Laws of the State of \_\_\_\_\_, as Surety, are held and firmly bound unto the Commonwealth of Virginia in the full and just sum of \_\_\_\_\_ U. S. Dollars (\$ \_\_\_\_\_), to be paid to the said Commonwealth of Virginia to the payment whereof we hereby bind ourselves and our heirs, executors, administrators, successors and assigns, jointly and severally, firmly by these presents, sealed and dated this \_\_\_\_ day of \_\_\_\_\_, A. D. \_\_\_\_\_.

**WHEREAS**, The said Principal hereunder has been or will be granted permit(s) authorizing one or more of the following activities;(A) to move house property upon public highways of Virginia (B) to cut surface of the highways of Virginia, or to tunnel under such highways; (C) to install and/or erect and maintain telephone, electric power lines, water, sewer, gas or other utilities on, under or over such highways, bridges or tunnels;(D) to install an entrance or tie-in into a public roadway and/or grading upon the Right-of-way; or (E) for the following purposes: Explain below exact purpose(s) for which surety coverage is being obtained.)

\_\_\_\_\_ Work to be performed in the county /or city of \_\_\_\_\_

**THEREFORE**, The conditions of this obligation are such that if the said Principal shall in all respects comply with the terms and conditions of said permit(s), and fully meet and perform obligations thereunder in accordance with requirements for permits as set forth in the Land Use Permit Manual and Hauling Permit Manual in effect at time of issuing permit, and shall satisfactorily complete the work permitted, and shall indemnify and save harmless the Commonwealth of Virginia against and from all loss, cost, expense damage or injury to highways and bridges and to persons and property lawfully on such highways, growing out of the granting of such permit(s) to said Principal, then this obligation be void, otherwise to be and remain in full force and virtue.

**NOW, THEREFORE**, It is expressly understood that this Bond may be canceled by the Surety at the expiration of sixty (60) days from the date which the Surety shall have lodged with the Commonwealth Transportation Commissioner or his designees written notice to so cancel. This provision, however, shall not operate to relieve, release or discharge the Surety from any liability already accrued, or which shall accrue, on permits issued before the expiration of the sixty-day period. **Bonds securing performance on specified active permit(s) may be canceled only upon satisfactory completion of permit(s), as determined by the Department Engineer.** NOTE: Continuous Bond cannot be canceled unless facilities covered by the permit have been removed from the Right-of-way, or the principal has arranged for replacement surety protection. **ALL permit work covered under section (C) above shall be covered by a bond at all times.**

Said principal and surety, being properly authorized, have caused these presents to be executed and their seals affixed the day and year first above written.

Surety Name _____	Principal Name _____
Bond Number _____	SSN or Tax IDN _____ - _____ - _____
Address _____	Address _____
City _____ State _____ ZCode _____	City _____ State _____ ZCode _____
Contact Person _____	Contact Person _____
Phone Number ( _____ ) _____ - _____	Phone Number ( _____ ) _____ - _____
Attorney-in-Fact Name _____	Signature _____
Signature _____	

---

# Proposed Regulations

---

Attorney-In-Fact  
(Seal)

**\* POWER OF ATTORNEY AUTHORIZATION TO BE ATTACHED**

## Acknowledgement of Principal

STATE OF \_\_\_\_\_  
COUNTY /TOWN/CITY OF \_\_\_\_\_

I, the undersigned, a Notary Public in and for the County /Town / City aforesaid, in the State aforesaid, do certify that, \_\_\_\_\_ whose name as Principal is signed to the foregoing writing bearing date on the \_\_\_\_\_ day of \_\_\_\_\_, \_\_\_\_\_, personally appeared before me and acknowledged the same.

Given under my hand this \_\_\_\_\_ day of \_\_\_\_\_, \_\_\_\_\_.

My Commission expires: \_\_\_\_\_.

\_\_\_\_\_  
Notary Public

## Affidavit and Acknowledgement of Surety

STATE OF \_\_\_\_\_  
COUNTY/TOWN/CITY OF \_\_\_\_\_

I, the undersigned, a Notary Public in and for the County/Town/City aforesaid, in the State aforesaid do certify that, \_\_\_\_\_ (Attorney in fact name) personally appeared before me and made oath that he is \_\_\_\_\_ (Title) of the \_\_\_\_\_ (Name of Surety), that he is duly authorized to execute the foregoing bond by virtue of a certain power of attorney of said company; that said power of attorney has not been revoked; that the said company has complied with all the requirements of law regulating the admission of such companies to transact business in the State of Virginia; that the said company holds the certificate of the Commissioner of Insurance authorizing it to do business in the State of Virginia; that it has a paid-up cash capital of not less than \$250,000; that the paid-up capital plus the surplus and undivided profits of said company is \$ \_\_\_\_\_; that the penalty of the foregoing bond is not in excess of ten percentum of said sum; that the said company is not by said bond incurring in the aggregate, on behalf or on account of the principal names in said bond, a liability for an amount larger than one-tenth of its paid-up capital, plus its surplus and undivided profits; that the said company is solvent and fully able to meet promptly all its obligations, and the said \_\_\_\_\_ (Attorney in fact name) thereupon, in the name and on behalf of the said company, acknowledged the foregoing writing as its act and deed.

Given under my hand this \_\_\_\_\_ day of \_\_\_\_\_, \_\_\_\_\_.

My Commission expires: \_\_\_\_\_.

\_\_\_\_\_  
Notary Public

Original to be filed with the Virginia Department of Transportation  
Request for Land Use Permit Surety Bond Cancellation may be addressed to:

Virginia Department of Transportation

\_\_\_\_\_  
\_\_\_\_\_  
\_\_\_\_\_

VA.R. Doc. No. R02-36; Filed October 22, 2002, 2:36 p.m.



---

# FINAL REGULATIONS

---

For information concerning Final Regulations, see Information Page.

---

## Symbol Key

Roman type indicates existing text of regulations. *Italic type* indicates new text. Language which has been stricken indicates text to be deleted. [Bracketed language] indicates a change from the proposed text of the regulation.

---

## TITLE 4. CONSERVATION AND NATURAL RESOURCES

### DEPARTMENT OF GAME AND INLAND FISHERIES

**REGISTRAR'S NOTICE:** The Board of Game and Inland Fisheries is exempt from the Administrative Process Act pursuant to subdivision A 3 of § 2.2-4002 of the Code of Virginia when promulgating regulations regarding the management of wildlife. The department is required by § 2.2-4031 of the Code of Virginia to publish all proposed and final wildlife management regulations, including length of seasons and bag limits allowed on the wildlife resources within the Commonwealth of Virginia.

**Title of Regulation:** 4 VAC 15-30. **Definitions and Miscellaneous: Importation, Possession, Sale, etc., of Animals (amending 4 VAC 15-30-40).**

**Statutory Authority:** §§ 29.1-501 and 29.1-502 of the Code of Virginia.

**Effective Date:** January 1, 2003.

#### Summary:

*The amendment adds the family of snakehead fish (Channidae) to the list of those nonnative (exotic) species for which importation, possession, cultivation, and sale in the Commonwealth is prohibited unless otherwise authorized by special permit.*

**Agency Contact:** Phil Smith, Policy Analyst and Regulatory Coordinator, 4010 West Broad Street, Richmond VA, 23230, telephone (804) 367-1000, FAX (804) 367-0488 or e-mail regcomments@dgif.state.va.us.

**REGISTRAR'S NOTICE:** The proposed regulation was adopted as published in 19:1 VA.R. 24-26 September 23, 2002, without change. Therefore, pursuant to § 2.2-4031 A of the Code of Virginia, the text of the final regulation is not set out.

VA.R. Doc. No. R03-10; Filed October 30, 2002, 11:12 a.m.

\*\*\*\*\*

**Title of Regulation:** 4 VAC 15-320. **Fish: Fishing Generally (amending 4 VAC 15-320-40 and 4 VAC 15-320-50; adding 4 VAC 15-320-25; repealing 4 VAC 15-320-20 and 4 VAC 15-320-30).**

**Statutory Authority:** §§ 29.1-501 and 29.1-502 of the Code of Virginia.

**Effective Date:** January 1, 2003.

#### Summary:

*The amendments (i) combine fishing creel limits and length (size) limits into one combined regulation section in a table format; (ii) establish a 14- to 20-inch bass slot limit (no bass 14 to 20 inches may be possessed), and that only one bass greater than 20 inches per day may be taken on the New River from Claytor Dam downstream to the Virginia-West Virginia state line; (iii) reduce the statewide daily creel limit for white bass from 25 fish per day to five fish per day; (iv) reduce the statewide daily creel limit for walleye from eight fish per day to five fish per day; (v) establish an 18-inch minimum length limit for walleye (no walleye less than 18 inches) in Flannagan and South Holston reservoirs; (vi) establish a 20-inch minimum length limit on walleye (no walleye less than 20 inches) in Claytor Lake and the New River upstream of Claytor Lake Dam; (vii) reduce the statewide daily creel limit for sauger from eight fish per day to two fish per day; (viii) reduce the statewide daily creel limit for chain pickerel from eight fish per day to five fish per day; and (ix) establish a 10-inch minimum length limit for crappie (no crappie less than 10 inches) in South Holston Reservoir.*

*The amendments further add the yellow perch to the list of species that may be sold from privately owned facilities and add Laurel Creek in Tazewell and Bland counties to the list of those waters in which the use of fish as bait is prohibited.*

**Agency Contact:** Phil Smith, Policy Analyst and Regulatory Coordinator, 4010 West Broad Street, Richmond VA, 23230, telephone (804) 367-1000, FAX (804) 367-0488 or e-mail regcomments@dgif.state.va.us.

**REGISTRAR'S NOTICE:** The proposed regulation was adopted as published in 19:1 VA.R. 26-33 September 23, 2002, without change. Therefore, pursuant to § 2.2-4031 A of the Code of Virginia, the text of the final regulation is not set out.

VA.R. Doc. No. R03-7; Filed October 30, 2002, 11:13 a.m.

\*\*\*\*\*

**Title of Regulation:** 4 VAC 15-330. **Fish: Trout Fishing (amending 4 VAC 15-330-10, 4 VAC 15-330-100, 4 VAC 15-330-120, 4 VAC 15-330-160, and 4 VAC 15-330-190).**

**Statutory Authority:** §§ 29.1-501 and 29.1-502 of the Code of Virginia.

**Effective Date:** January 1, 2003.

#### Summary:

*The amendments (i) close Trout Heritage Day waters to fishing on the Friday prior to the first Saturday in April, with trout fishing reopening at 9 a.m. on the first Saturday in April; (ii) clarify that "artificial lure" does not include*

---

# Final Regulations

---

*artificially produced organic baits intended to be ingested by fish, and "artificial lures with single hook" means any single point lure; (iii) remove Sinking Creek from the list of special regulation trout waters on which the minimum size for trout that may be taken is 16 inches and the creel limit is two trout per day; (iv) remove the reference to single hook to be consistent with the artificial lure guidance for all other designated stocked trout waters in 4 VAC 15-330-60; (v) add a 2.6-mile section of the Hardware River (in the Hardware Wildlife Management Area, Fluvanna County), a 1.2-mile section of Holmes Run (Fairfax County), and a 2.2-mile section of Roanoke River (City of Salem) to delayed harvest trout waters in which trout may be creeled from June 1 through September 30, but are "catch and release" from October 1 through May 31; and (vi) include the James River and New River as waters where commercially raised rainbow trout can be sold and used as bait.*

**Agency Contact:** Phil Smith, Policy Analyst and Regulatory Coordinator, 4010 West Broad Street, Richmond VA, 23230, telephone (804) 367-1000, FAX (804) 367-0488 or e-mail regcomments@dgif.state.va.us.

**REGISTRAR'S NOTICE:** The proposed regulation was adopted as published in 19:1 VA.R. 33-34 September 23, 2002, without change. Therefore, pursuant to § 2.2-4031 A of the Code of Virginia, the text of the final regulation is not set out.

VA.R. Doc. No. R03-8; Filed October 30, 2002, 11:13 a.m.

\*\*\*\*\*

**Title of Regulation:** **4 VAC 15-340. Fish: Seines and Nets (amending 4 VAC 15-340-60).**

**Statutory Authority:** §§ 29.1-501 and 29.1-502 of the Code of Virginia.

**Effective Date:** January 1, 2003.

**Summary:**

*The amendment adds Laurel Creek in Tazewell and Bland counties to the list of waters in which the use of seines, nets and traps for the taking of fish is prohibited.*

**Agency Contact:** Phil Smith, Policy Analyst and Regulatory Coordinator, 4010 West Broad Street, Richmond VA, 23230, telephone (804) 367-1000, FAX (804) 367-0488 or e-mail regcomments@dgif.state.va.us.

**REGISTRAR'S NOTICE:** The proposed regulation was adopted as published in 19:1 VA.R. 35 September 23, 2002, without change. Therefore, pursuant to § 2.2-4031 A of the Code of Virginia, the text of the final regulation is not set out.

VA.R. Doc. No. R03-9; Filed October 30, 2002, 11:14 a.m.

\*\*\*\*\*

**Title of Regulation:** **4 VAC 15-350. Fish: Gigs, Grab Hooks, Trotlines, Snares, etc. (amending 4 VAC 15-350-30).**

**Statutory Authority:** §§ 29.1-501 and 29.1-502 of the Code of Virginia.

**Effective Date:** January 1, 2003.

**Summary:**

*The amendment removes the Holston River in Scott County and the North Fork Holston River in Washington County from the list of waters where nongame fish may be taken by snagging, grabbing, snaring, gigging and with a striking iron.*

**Agency Contact:** Phil Smith, Policy Analyst and Regulatory Coordinator, 4010 West Broad Street, Richmond VA, 23230, telephone (804) 367-1000, FAX (804) 367-0488 or e-mail regcomments@dgif.state.va.us.

**REGISTRAR'S NOTICE:** The proposed regulation was adopted as published in 19:1 VA.R. 35 September 23, 2002, without change. Therefore, pursuant to § 2.2-4031 A of the Code of Virginia, the text of the final regulation is not set out.

VA.R. Doc. No. R03-11; Filed October 30, 2002, 11:14 a.m.

\*\*\*\*\*

**Title of Regulation:** **4 VAC 15-360. Fish: Aquatic Invertebrates, Amphibians, Reptiles, and Nongame Fish (amending 4 VAC 15-360-10).**

**Statutory Authority:** §§ 29.1-501 and 29.1-502 of the Code of Virginia.

**Effective Date:** January 1, 2003.

**Summary:**

*The amendment adds the snail bullhead (Ameiurus brunneus) to the list of species that may be taken in unlimited numbers from inland waters of the Commonwealth.*

**Agency Contact:** Phil Smith, Policy Analyst and Regulatory Coordinator, 4010 West Broad Street, Richmond VA, 23230, telephone (804) 367-1000, FAX (804) 367-0488 or e-mail regcomments@dgif.state.va.us.

**REGISTRAR'S NOTICE:** The proposed regulation was adopted as published in 19:1 VA.R. 35-36 September 23, 2002, without change. Therefore, pursuant to § 2.2-4031 A of the Code of Virginia, the text of the final regulation is not set out.

VA.R. Doc. No. R03-12; Filed October 30, 2002, 11:14 a.m.

\*\*\*\*\*

**REGISTRAR'S NOTICE:** The Board of Game and Inland Fisheries is exempt from the Administrative Process Act pursuant to § 29.1-701 E of the Code of Virginia, which provides that proposal and adoption of regulations implementing Chapter 7 of Title 29.1 shall take place as described in Article 1 (§ 29.1-500 et seq.) of Chapter 5 of Title 29.1 of the Code of Virginia. The department is required by § 2.2-4031 of the Code of Virginia to publish all proposed and final regulations.

**Title of Regulation:** 4 VAC 15-370. **Watercraft: In General (amending 4 VAC 15-370-50; adding 4 VAC 15-370-51, 4 VAC 15-370-70, and 4 VAC 15-370-80; repealing 4 VAC 15-370-10 and 4 VAC 15-370-30).**

**Statutory Authority:** §§ 29.1-501, 29.1-502, 29.1-701, 29.1-735, and 29.1-744 of the Code of Virginia.

**Effective Date:** January 1, 2003.

**Summary:**

*The amendments establish rules and procedures for authorizing or canceling waterway regulatory markers, set standards for the appearance and construction of the markers, require watercraft operators to obey the markets, and prohibit activities and actions that may damage or alter approved markers.*

*Three new sections are added to the regulation to: (i) require those authorized to place markers to maintain the visibility and readability of the marker or remove them and also authorizes the department to remove them or require they be removed at the owner's expense; (ii) authorize the department to issue hull identification numbers and motor serial numbers or their replacements, and make it unlawful to destroy or alter those numbers unless authorized in writing; and (iii) define the penalty for a violation of the regulation. In future regulatory action, the department will adopt new watercraft safety equipment and operating requirements and is currently repealing the section that adopted federal regulations and laws related to those issues. The department is repealing the section requiring at least one white light for motorboats anchored or drifting.*

**Agency Contact:** Phil Smith, Policy Analyst and Regulatory Coordinator, 4010 West Broad Street, Richmond VA, 23230, telephone (804) 367-1000, FAX (804) 367-0488 or e-mail regcomments@dgif.state.va.us.

**REGISTRAR'S NOTICE:** The proposed regulation was adopted as published in 19:1 VA.R. 36-38 September 23, 2002, without change. Therefore, pursuant to § 2.2-4031 A of the Code of Virginia, the text of the final regulation is not set out.

VA.R. Doc. No. R03-13; Filed October 30, 2002, 11:15 a.m.

\*\*\*\*\*

**Title of Regulation:** 4 VAC 15-380. **Watercraft: Motorboat Numbering (amending 4 VAC 15-380-30, 4 VAC 15-380-40, 4 VAC 15-380-50, and 4 VAC 15-380-70; adding 4 VAC 15-**

**380-80 through 4 VAC 15-380-130; repealing 4 VAC 15-380-10, 4 VAC 15-380-20, and 4 VAC 15-380-60).**

**Statutory Authority:** §§ 29.1-501, 29.1-502, 29.1-701, and 29.1-735 of the Code of Virginia and Item 392 of the 2002 Appropriation Act.

**Effective Date:** January 1, 2003.

**Summary:**

*The amendments:*

- 1. Eliminate specific requirements for what information must be on an application for a certificate of number and title;*
- 2. Provide a better numbering example in the regulation section that specifies the format of the registration numbers that must be affixed to watercraft;*
- 3. Authorize the use of a backing plate for the display of numbers when the hull or superstructure is so configured that numbers would not be easily visible or the numbers would not remain securely attached;*
- 4. Remove a requirement that notifications of a change in status of a registered or titled vessel or owner must be made on a form provided by the department: notification in writing, including electronic media and facsimile, will be acceptable;*
- 5. Eliminate the requirement for application for a duplicate certificate of number to be on a form provided by the department, the fee for the duplicate, and a restriction that not more than one certificate of number may be in existence at any one time: the fee for duplicate certificates will be established in 4 VAC 15-380-120;*
- 6. Authorize the department to cancel and recall watercraft titles when necessary, and require the owners to surrender recalled titles upon demand;*
- 7. Establish that the effective date of cancellations of registrations or titles is the day the request was processed or up to 15 days prior to that day provided sufficient evidence is provided that the owner lost interest in the watercraft within those 15 days;*
- 8. Authorize game wardens to inspect watercraft for which an application for certificate of registration or title has been received by the department;*
- 9. Clarify that the reduced registration rates when an owner registers 10 or more watercraft apply only when 10 watercraft are actively registered;*
- 10. Clarify that lifeboats exempted from registration requirements differ from tenders in that they are used exclusively as lifesaving devices during times of emergency;*
- 11. Establish fees for certificates of registration; and*
- 12. Define the penalty for violation of this regulation.*

**Agency Contact:** Phil Smith, Policy Analyst and Regulatory Coordinator, 4010 West Broad Street, Richmond VA, 23230, telephone (804) 367-1000, FAX (804) 367-0488 or e-mail regcomments@dgif.state.va.us.

---

# Final Regulations

---

**REGISTRAR'S NOTICE:** The proposed regulation was adopted as published in 19:1 VA.R. 38-40 September 23, 2002, without change. Therefore, pursuant to § 2.2-4031 A of the Code of Virginia, the text of the final regulation is not set out.

VA.R. Doc. No. R03-14; Filed October 30, 2002, 11:15 a.m.

\*\*\*\*\*

**Title of Regulation:** 4 VAC 15-390. **Watercraft: Safe and Reasonable Operation of Vessels (amending 4 VAC 15-390-10, 4 VAC 15-390-20, 4 VAC 15-390-30, 4 VAC 15-390-50, 4 VAC 15-390-70, 4 VAC 15-390-90, 4 VAC 15-390-100, 4 VAC 15-390-110, and 4 VAC 15-390-130; adding 4 VAC 15-390-11, 4 VAC 15-390-140, 4 VAC 15-390-150, and 4 VAC 15-390-160).**

**Statutory Authority:** §§ 29.1-501, 29.1-502, 29.1-701, and 29.1-735 of the Code of Virginia.

**Effective Date:** January 1, 2003.

**Summary:**

*The amendments (i) apply boating safety operation requirements currently applied to public waters to the private waters, and consolidate the "operation in narrow channels" portion of this regulation; (ii) establish uniform definitions for words and terms used in this chapter and define the terms "right" and "left" as substitutes for the terms "starboard" and "port"; (iii) direct motorboat operators approaching another vessel head-on to alter course to the right so the boats pass on the left side of each vessel unless sufficient separation exists that the boats may safely pass on the right side of each vessel; (iv) provide direction to motorboat operators approaching another vessel in a crossing situation; (v) conform the regulation dealing with right-of-way of various vessels to Inland Navigation Rules 12 and 18 of the U.S. Coast Guard; (vi) require the operators of all vessels to maintain a proper lookout by sight, sound and all other available means; (vii) require (a) watercraft operators to maintain a safe speed when their vision is obscured, (b) the avoidance of certain course alterations when another vessel is detected by radar alone, and (c) safe speed operation when a fog signal is heard; (viii) direct watercraft operators when navigating in narrow channels to keep to the right to the extent practicable, and if in the channel, to not interfere with larger vessels that can safely navigate only in the channel; (ix) authorize the operator of the stand-on vessel to take actions necessary to avoid immediate danger of a collision without relieving the operator of the give-way vessel of his obligations to keep out of the way of the stand-on vessel; (x) provide the meanings of standard horn and whistle signals for communications between vessels and require use of only these standard horn and whistle signals should the vessel operators choose this method of communication; (xi) clarify in regulation the reckless operation associated with allowing passengers to ride or sit on the gunwales, bow, or transom of a watercraft while it is under power; (xii) make it unlawful to operate a watercraft in excess of a speed that would allow the operator to take proper and effective action to*

*avoid a collision or stop as needed; and (xiii) clearly define the penalty for violation of any provision of this chapter.*

**Agency Contact:** Phil Smith, Policy Analyst and Regulatory Coordinator, 4010 West Broad Street, Richmond VA, 23230, telephone (804) 367-1000, FAX (804) 367-0488 or e-mail regcomments@dgif.state.va.us.

**REGISTRAR'S NOTICE:** The proposed regulation was adopted as published in 19:1 VA.R. 40-44 September 23, 2002, without change. Therefore, pursuant to § 2.2-4031 A of the Code of Virginia, the text of the final regulation is not set out.

VA.R. Doc. No. R03-15; Filed October 30, 2002, 11:16 a.m.

\*\*\*\*\*

**Title of Regulation:** 4 VAC 15-400. **Watercraft: Accident and Casualty Reporting (amending 4 VAC 15-400-20 and 4 VAC 15-400-30; adding 4 VAC 15-400-50).**

**Statutory Authority:** §§ 29.1-501, 29.1-502, 29.1-701, and 29.1-735 of the Code of Virginia.

**Effective Date:** January 1, 2003.

**Summary:**

*The amendments (i) require immediate notification of a game warden or the Richmond Headquarters of the Department of Game and Inland Fisheries of all reportable accidents; (ii) conform the regulation to the dollar loss threshold as established by the United States Coast Guard for reportable boating accidents; and (iii) clearly define the penalty for violation of any provision of this chapter.*

**Agency Contact:** Phil Smith, Policy Analyst and Regulatory Coordinator, 4010 West Broad Street, Richmond VA, 23230, telephone (804) 367-1000, FAX (804) 367-0488 or e-mail regcomments@dgif.state.va.us.

**REGISTRAR'S NOTICE:** The proposed regulation was adopted as published in 19:1 VA.R. 44 September 23, 2002, without change. Therefore, pursuant to § 2.2-4031 A of the Code of Virginia, the text of the final regulation is not set out.

VA.R. Doc. No. R03-16; Filed October 30, 2002, 11:17 a.m.

\*\*\*\*\*

**Title of Regulation:** 4 VAC 15-420. **Watercraft: Navigation Lights and Shapes (adding 4 VAC 15-420-10 through 4 VAC 15-420-120).**

**Statutory Authority:** §§ 29.1-501, 29.1-502, 29.1-701, and 29.1-735 of the Code of Virginia.

**Effective Date:** January 1, 2003.

**Summary:**

*The final action establishes a new regulation by adapting the federal rules for inland waters navigation lights and shapes to Virginia and establishing the applicability of those rules in relation to the weather, sunrise and sunset.*



Agency Contact: Phil Smith, Policy Analyst and Regulatory Coordinator, 4010 West Broad Street, Richmond VA, 23230, telephone (804) 367-1000, FAX (804) 367-0488 or e-mail regcomments@dgif.state.va.us.

**REGISTRAR'S NOTICE:** The proposed regulation was adopted as published in 19:1 VA.R. 45-49 September 23, 2002, without change. Therefore, pursuant to § 2.2-4031 A of the Code of Virginia, the text of the final regulation is not set out.

VA.R. Doc. No. R03-17; Filed October 30, 2002, 11:18 a.m.

\*\*\*\*\*

Title of Regulation: **4 VAC 15-430. Watercraft: Safety Equipment Requirements (adding 4 VAC 15-430-10 through 4 VAC 15-430-220).**

Statutory Authority: §§ 29.1-501, 29.1-502, 29.1-701, and 29.1-735 of the Code of Virginia.

Effective Date: January 1, 2003.

Summary:

*The final action establishes safety equipment requirements and conforms to federal rules governing watercraft equipment requirements for vessels on inland waters.*

Agency Contact: Phil Smith, Policy Analyst and Regulatory Coordinator, 4010 West Broad Street, Richmond VA, 23230, telephone (804) 367-1000, FAX (804) 367-0488 or e-mail regcomments@dgif.state.va.us.

**REGISTRAR'S NOTICE:** The proposed regulation was adopted as published in 19:1 VA.R. 49-54 September 23, 2002, without change. Therefore, pursuant to § 2.2-4031 A of the Code of Virginia, the text of the final regulation is not set out.

VA.R. Doc. No. R03-18; Filed October 30, 2002, 11:18 a.m.

\*\*\*\*\*

Title of Regulation: **4 VAC 15-440. Watercraft: Commercial Vessel Safety Equipment Requirements (adding 4 VAC 15-440-10 through 4 VAC 15-440-60).**

Statutory Authority: §§ 29.1-501, 29.1-502, 29.1-701, and 29.1-735 of the Code of Virginia.

Effective Date: January 1, 2003.

Summary:

*The final action establishes safety equipment requirements for commercial vessels and conforms to federal rules governing watercraft equipment requirements for vessels on the waters of the United States.*

Agency Contact: Phil Smith, Policy Analyst and Regulatory Coordinator, 4010 West Broad Street, Richmond VA, 23230, telephone (804) 367-1000, FAX (804) 367-0488 or e-mail regcomments@dgif.state.va.us.

**REGISTRAR'S NOTICE:** The proposed regulation was adopted as published in 19:1 VA.R. 54-55 September 23, 2002, without change. Therefore, pursuant to § 2.2-4031 A of the Code of Virginia, the text of the final regulation is not set out.

VA.R. Doc. No. R03-19; Filed October 30, 2002, 11:19 a.m.

**MARINE RESOURCES COMMISSION**

**REGISTRAR'S NOTICE:** The following regulation filed by the Marine Resources Commission is exempt from the Administrative Process Act in accordance with § 2.2-4006 A 12 of the Code of Virginia; however, the commission is required to publish the full text of final regulations.

Title of Regulation: **4 VAC 20-720. Pertaining to Restrictions on Oyster Harvest (amending 4 VAC 20-720-80).**

Statutory Authority: §§ 28.2-201 and 28.2-507 of the Code of Virginia.

Effective Date: November 1, 2002.

Summary:

*The amendment makes the failure to report oysters harvested on a daily basis or failure to pay oyster taxes subject to the forfeiture of all harvested oysters and revocation of the dredge gear license for the remainder of the season.*

Agency Contact: Katherine V. Leonard, Marine Resources Commission, 2600 Washington Avenue, 3rd Floor, Newport News, VA 23607, telephone (757) 247-2248 or FAX (757) 247-2002.

**4 VAC 20-720-80. Quotas and harvest limits.**

A. In the James River Seed Area, including the Deep Water Shoal State Replenishment Seed Area, there shall be an oyster harvest quota of 80,000 bushels of seed oysters. It shall be unlawful for any person to harvest seed oysters from the James River Seed Area after the 80,000 bushel quota has been reached. In the James River Seed Area, including the Deep Water Shoal State Replenishment Seed Area, and Clean Cull Areas there shall be an oyster harvest quota of 15,000 bushels of market oysters. It shall be unlawful for any person to harvest market oysters from the James River Seed and Clean Cull Areas after the 15,000 bushel quota has been reached.

B. The lawful daily limit of clean cull oysters harvested from the areas as described in subdivisions 4 through 10 and 12 and 13 of 4 VAC 20-720-40 shall be determined by the number of registered ~~certified~~ commercial fishermen licensees on board the vessel multiplied by eight bushels. It shall be unlawful to possess on board any vessel or to land more than the daily limit of clean cull oysters.

C. In the PTSMA in Tangier Sound, from Tangier Light north to the Maryland-Virginia line, and in the Pocomoke Sound, northeast from a line from Beach Island Light to the house on the Great Fox Island, where harvesting is allowed by dredge, there shall be a harvest limit of 15 bushels per day, per

---

# Final Regulations

---

vessel. It shall be unlawful to possess on board any vessel more than 15 bushels per day. No hard clam or blue crab bycatch is allowed. Failure to report oysters harvested on a daily basis ~~or violation of any requirements for the harvesting of oysters~~ or pay oyster taxes shall result in the forfeiture of all harvested oysters and revocation of the dredge gear license for the remainder of the season.

D. In the Deep Rock Dredge Area there shall be a harvest limit of 15 bushels per day per vessel. It shall be unlawful to possess on board any vessel or to land more than 15 bushels per day per vessel. No hard clam or blue crab bycatch is allowed.

VA.R. Doc. No. R03-62; Filed October 28, 2002, 11:16 a.m.



---

# EMERGENCY REGULATIONS

---

## TITLE 4. CONSERVATION AND NATURAL RESOURCES

### MARINE RESOURCES COMMISSION

**Title of Regulation:** 4 VAC 20-754. **Pertaining to Importation of Fish, Shellfish or Crustacea (amending 4 VAC 20-754-10, 4 VAC 20-754-20, and 4 VAC 20-754-30).**

**Statutory Authority:** §§ 28.2-201, 28.2-210 and 28.2-825 of the Code of Virginia.

**Effective Dates:** October 27, 2002, through November 25, 2002.

**Summary:**

*The amendments specify the conditions under which hard clam seed may be imported to Virginia from facilities in South Carolina and Florida.*

**Agency Contact:** Deborah R. Cawthon, Regulatory Coordinator, Marine Resources Commission, 2600 Washington Avenue, 3rd Floor, Newport News, VA, telephone (757) 247-2248, FAX (757) 247-2002 or e-mail dcawthon@mrc.state.va.us.

#### **4 VAC 20-754-10. Purpose.**

The purpose of this *emergency* chapter is to establish the list of approved states, waters and species, and criteria necessary for the importation of fish, shellfish, and crustacea for the purpose of placing such animals into the waters of the Commonwealth.

#### **4 VAC 20-754-20. Definitions.**

The following words and terms, when used in this *emergency* chapter, shall have the following meanings unless the context clearly indicates otherwise.

*"Shell height"* means the straight-line distance from the hinge of the mollusk to its bill.

*"Shell length"* means the longest straight-line distance on the mollusk from edge to edge.

#### **4 VAC 20-754-30. Approved species and criteria for importation.**

A. Pursuant to the provisions of § 28.2-825 of the Code of Virginia and under the following conditions, it shall be lawful to import into the Commonwealth, with the intent of placing such animals into the waters of the Commonwealth, any species listed below, except as prohibited in the exception contained in subdivision 1 of this subsection:

1. Any hard clam of the species *Mercenaria mercenaria* from the waters of any coastal area or state within the continental United States and that is absent of any known shellfish pathogen, as specified in subsection B of this section, except that any importation of hatchery-produced seed of the genus *Mercenaria* from Pacific coastal states within the continental United States, ~~South Carolina or Florida shall be prohibited for a period of 180 days, starting August 28, 2002.~~ , and any importation of hatchery-

*produced seed of the genus Mercenaria from South Carolina or Florida shall meet all requirements established by 4 VAC 20-754-30 A 1 a through d. Importation requirements established by 4 VAC 20-754-30 A 1 a through d shall be in addition to those importation requirements established by 4 VAC 20-754-30 B.*

a. *The South Carolina or Florida hatchery or facility shall certify that only northern broodstock clams of the genus Mercenaria, absent of shellfish pathogens, were used to produce hard clam seed that is to be exported to Virginia. The certification shall be accompanied by evidence that the facility took possession of the northern broodstock hard clams within the previous 12 months.*

b. *The South Carolina or Florida hatchery or facility shall certify that any clam seed scheduled for importation into Virginia was produced from broodstock that satisfies the requirements specified by 4 VAC 20-754-30 A 1 a.*

c. *The South Carolina or Florida hatchery or facility shall certify that only hard clams of northern broodstock were held in the facility used for spawning purposes throughout the time period, within a calendar year, corresponding to all shipments of hard clam seed to Virginia, and all shipments of clam seed shall be accompanied by a tag indicating the name of the hatchery or facility and the quantity, on a per bag or container basis.*

d. *Any certification requirements described in 4 VAC 20-754-30 A 1 a and b shall accompany the certified statement from an approved shellfish pathologist as to the complete absence of known shellfish pathogens in a random sample of hard clam seed of the genus Mercenaria scheduled for importation into Virginia, as described in 4 VAC 20-754-30 B. All certified statements required for importation of hard clam seed of genus Mercenaria, as specified by 4 VAC 20-754-30 A 1 a and b and 4 VAC 20-754-30 B shall be provided to the Virginia Marine Resources Commission, Fisheries Management Division at least 10 days prior to the shipment of any hard clam seed of genus Mercenaria.*

2. Any American oyster shellstock of the species *Crassostrea virginica* greater than 25mm in shell height from the waters of New England, Mid-Atlantic, or South Atlantic coastal areas or states and that is absent of any known shellfish pathogen, as specified in subsection B of this section.

3. Any American oyster hatchery-produced seed of the species *Crassostrea virginica* less than 25mm in shell height from the waters of any coastal area or state within the Continental United States and that is absent of any known shellfish pathogen, as specified in subsection B of this section.

4. Any bay scallop hatchery-produced seed of the species *Argopecten irradians* less than 25mm in shell height from the waters of any coastal area or state within the continental United States and that is absent of any known shellfish pathogen, as specified in subsection B of this section.

5. Any surf clam hatchery-produced seed of the species *Spisula solidissima* less than 25mm in shell length from the

---

# Emergency Regulations

---

waters of any coastal area or state within the continental United States and that is absent of any known shellfish pathogen, as specified in subsection B of this section.

6. Any soft shell clam-hatchery-produced-seed of the species *Mya arenaria* less than 25mm in shell length from the waters of any coastal area or state within the United States and that is absent of any known shellfish pathogen.

7. Any pre-molt (peeler) blue crab of the species *Callinectes sapidus* from the waters of the states of New Jersey, Delaware, Maryland, North Carolina, South Carolina, or Georgia.

B. In order to import any species described in subsection A of this section, a certified statement from an approved shellfish pathologist as to the complete absence of known shellfish pathogens in a random sample shall be provided. That certified statement shall be provided to the Virginia Marine Resources Commission, Fisheries Management Division, at least 10 days prior to the shipment of any molluscan shellfish specified above for introduction into the waters of the Commonwealth. The test for shellfish pathogens in all shellfish species except oysters shall be from a random sample of 60 individuals from the shipment or population in question that was examined by histological and fluid thioglycollate methods within 60 days of each importation. For oysters, samples shall be tested within 30 days of each importation.

C. Shipments of any molluscan shellfish specified above, upon entry into the Commonwealth for introduction into the waters of the Commonwealth, shall be accompanied by a certified statement from an approved shellfish pathologist as to the complete absence of known shellfish pathogens in a random sample of 60 individuals from the shipment or population in question and written acknowledgement from the Virginia Marine Resources Commission on the receipt of such statement.

D. Shipments of any species under the provisions of this chapter shall be accompanied by documentation of the quantity imported.

E. The provisions of the chapter shall not apply to the importation of any molluscan shellfish from the waters of the Delaware Bay or the Maryland portion of the Chesapeake Bay and its tributaries.

VA.R. Doc. No. R03-60; Filed October 24, 2002, 3:11 p.m.



---

# GOVERNOR

---

EXECUTIVE ORDER NUMBER 37 (2002)

## **ESTABLISHING THE NORTHERN VIRGINIA AND HAMPTON ROADS TRANSPORTATION ACCOUNTABILITY COMMITTEES**

It is important to maintain the public trust in state government. To ensure that 100 percent of the funds generated by passage of the two transportation referenda will remain in the specific areas and be used only for the transportation purposes set forth by law, by virtue of the authority vested in me as Governor under Article V of the Constitution of Virginia and under the laws of the Commonwealth, including but not limited to Chapter 1 of Title 2.2 of the Code of Virginia, and subject to my continuing and ultimate authority and responsibility to act in such matters, I hereby establish the Northern Virginia Transportation Accountability Committee and the Hampton Roads Transportation Accountability Committee.

These citizen Committees will ensure that the legal mandate to dedicate all funds to the specific transportation programs in the two regions is met. In short, the Committees will make absolutely certain that all of the revenues generated upon the successful passage of the Northern Virginia transportation referendum will remain in Northern Virginia for transportation purposes and make absolutely certain that all of the revenues generated by the Hampton Roads transportation referendum will remain in Hampton Roads for transportation purposes.

### **Mission and Composition of the Citizen Accountability Committees**

The Committees will be required to review annual audits, financial reports, and performance reports of the Northern Virginia Transportation Authority and the Hampton Roads Planning District Commission, and to report annually to the Governor and General Assembly on the following:

Compliance with the statutory requirement that referendum proceeds must be used for the transportation projects and programs specified in Chapter 853 of the 2002 Acts of Assembly and may not be diverted to any other uses or any other regions of the Commonwealth.

Compliance with the required maintenance of local financial effort for transportation, as defined in Chapter 853 of the 2002 Acts of Assembly.

Compliance with the requirement that referendum revenues not be used to calculate or reduce any federal, state or local funds otherwise available to the localities or regions, as specified in Chapter 853 of the Acts of Assembly of 2002.

Compliance with limitations on the use of referendum proceeds for administrative purposes, as specified in Chapter 853 of the 2002 Acts of Assembly.

The Committees shall present their annual reports to the Governor and the General Assembly no later than December 1st of each year.

The members of the Committees shall be appointed by the Governor and shall serve for fixed terms of four years.

Members may not be removed prior to the end of their appointed term. The Governor shall designate a chairman of each Committee. Members of the Committees shall serve without compensation, but they may receive reimbursement for expenses incurred in the discharge of their official duties upon approval of the Chief of Staff.

Staff support necessary for the work of the Committees shall be provided by the Office of the Secretary of Finance and such executive branch agencies as the Governor may designate. An estimated 250 hours of staff time shall be needed to support the work of the Committees.

This Executive Order shall be effective immediately upon its signing and shall remain in full force and effect unless amended or rescinded by further Executive Order.

Given under my hand and the Seal of the Commonwealth of Virginia, this 18th day of October 2002.

/s/ Mark R. Warner  
Governor

VA.R. Doc. No. R03-61; Filed October 25, 2002, 11:23 a.m.

---

# FORMS

---

## TITLE 14. INSURANCE

### STATE CORPORATION COMMISSION

**EDITOR'S NOTICE:** The following forms have been revised by the State Corporation Commission. The forms are available for public inspection at the State Corporation Commission, 1300 East Main Street, Richmond, VA 23219. Copies of the forms may be obtained from the State Corporation Commission, P.O. Box 1157, Richmond, VA 23218, telephone (804) 371-9333 or e-mail [kdkelley@scc.state.va.us](mailto:kdkelley@scc.state.va.us).

**Title of Regulation: 14 VAC 5-350. Rules Governing Surplus Lines Insurance.**

Attached are surplus lines broker reports (SLB-3 and SLB-4) that have been revised for use by the Bureau of Insurance. The revised reports include only minor housekeeping changes.

**Contact Person:** Keith D. Kelley, 1300 East Main Street, Richmond, VA 23219, or P.O. Box 1157, Richmond, VA 23218, telephone (804) 371-9333 or e-mail [kdkelley@scc.state.va.us](mailto:kdkelley@scc.state.va.us).

VIRGINIA FORM SLB-3

QUARTERLY COMBINED AFFIDAVIT BY SURPLUS LINES BROKER

Re:

INSURANCE ON VIRGINIA RISK PLACED WITH AN UNLICENSED INSURER

STATE OF \_\_\_\_\_, CITY/COUNTY OF \_\_\_\_\_:

I, \_\_\_\_\_, \_\_\_\_\_, being duly sworn, affirm:  
(Authorized Individual) (Ind. P&C License No.)

1. THAT I, \_\_\_\_\_, \_\_\_\_\_ a duly licensed Surplus Lines  
(Surplus Lines Broker) (Broker License No.)

Broker authorized under Chapter 48 (~~§ 38.2-4800 et seq.~~) 18 (§ 38.2-1800 et seq.) of Title 38.2 of the Code of Virginia, was engaged by the insureds named on the attached quarterly report or Property and Casualty Agents duly licensed in this Commonwealth acting in on behalf of the insureds named on the attached quarterly report to obtain insurance against certain risks during the calendar quarter ending \_\_\_\_\_.

2. THAT I, if the transaction involves insurance primarily for personal, family, or household needs rather than business or professional needs, have complied with the provisions of Chapter 6 (§ 38.2-600 et seq.) of Title 38.2 of the Code of Virginia and subsection C of 14 VAC 5-350-90 by giving the prospective insured the required adverse underwriting decision notice, copies of which are attached to the quarterly report.

3. THAT each of the insureds named on the attached quarterly report have been given the notice required by subsection B of § 38.2-4806 of the Code of Virginia and ~~14 VAC 5-350-120~~ 14 VAC 5-350-95.

4. THAT I, have complied with the diligent effort requirements of § 38.2-4806 of the Code of Virginia for each policy listed on the attached quarterly report by:

- A. Obtaining a signed waiver of a diligent search from commercial insureds listed on the attached quarterly report and a copy of the signed waiver (Form SLB-10) is attached to the quarterly report; or
- B. In the instance of business that is referred from a licensed property and casualty insurance agent and listed on the attached quarterly report, such business was rejected or declined by at least three insurers licensed to transact such class of insurance; or
- C. In the instance of business that was originated by me and listed on the attached quarterly report, such business was rejected or declined by three unaffiliated insurers licensed to transact such class of insurance.

5. THAT the gross premiums written during the calendar quarter ending \_\_\_\_\_ are \$ \_\_\_\_\_ and the amount of the tax (2.25%) applicable thereto is \$ \_\_\_\_\_.

6. THAT the insurance described herein has been effected with the unlicensed insurers named herein.

\_\_\_\_\_  
Surplus Lines Broker

By \_\_\_\_\_  
(Authorized individual if licensee is a Corporation or Partnership)

SUBSCRIBED AND SWORN TO before me this \_\_\_\_ day of \_\_\_\_\_.

\_\_\_\_\_  
Notary Public

My Commission expires \_\_\_\_\_.

VIRGINIA FORM SLB-4

ANNUAL COMBINED AFFIDAVIT BY SURPLUS LINES BROKER

Re:

INSURANCE ON VIRGINIA RISK PLACED WITH AN UNLICENSED INSURER

STATE OF \_\_\_\_\_, CITY/COUNTY OF \_\_\_\_\_:

I, \_\_\_\_\_, \_\_\_\_\_, being duly sworn, affirm:  
(Authorized Individual) (Ind. P&C License No.)

1. THAT I, \_\_\_\_\_, \_\_\_\_\_ a duly licensed Surplus Lines  
(Surplus Lines Broker) (Broker License No.)

Broker authorized under Chapter ~~48~~ (§ ~~38.2-4800 et seq.~~) 18 (§ 38.2-1800 et seq.) of Title 38.2 of the Code of Virginia, was engaged by the insureds named on the attached quarterly report or Property and Casualty Agents duly licensed in this Commonwealth acting in on behalf of the insureds named on the attached annual report to obtain insurance against certain risks during the calendar year ending \_\_\_\_\_.

2. THAT I, if the transaction involves insurance primarily for personal, family, or household needs rather than business or professional needs, have complied with the provisions of Chapter 6 (§ 38.2-600 et seq.) Title 38.2 of the Code of Virginia and subsection C of 14 VAC 5-350-90 by giving the prospective insured the required adverse underwriting decision notice, copies of which have previously been submitted with quarterly reports or are attached to the annual report.

3. THAT each of the insureds named on the attached annual report have been given the notice required by subsection B of § 38.2-4806 of the Code of Virginia and ~~14 VAC 5-350-120~~ 14 VAC 5-350-95.

4. THAT I, have complied with the diligent effort requirements of § 38.2-4806 of the Code of Virginia for each policy listed on the attached annual report by:

- A. Obtaining a signed waiver of a diligent search from commercial insureds listed on the attached annual report and a copy of the signed waiver (Form SLB-10) was previously submitted with quarterly reports or are attached to the annual report; or
- B. In the instance of business that is referred from a licensed property and casualty insurance agent and listed on the attached annual report, such business was rejected or declined by at least three insurers licensed to transact such class of insurance; or
- C. In the instance of business that was originated by me and listed on the attached annual report, such business was rejected or declined by three unaffiliated insurers licensed to transact such class of insurance.

5. THAT the gross premiums written during the calendar year ending \_\_\_\_\_ are \$ \_\_\_\_\_ and the amount of the tax (2.25%) applicable thereto is \$ \_\_\_\_\_.

6. THAT the insurance described herein has been effected with the unlicensed insurers named herein.

\_\_\_\_\_  
Surplus Lines Broker

By \_\_\_\_\_  
(Authorized individual if licensee  
is a Corporation or Partnership)

SUBSCRIBED AND SWORN TO before me this \_\_\_\_ day of \_\_\_\_\_.

\_\_\_\_\_  
Notary Public

My Commission expires \_\_\_\_\_.

VIRGINIA FORM SLB-4 (Rev. 9/99/10/02)





---

# GENERAL NOTICES/ERRATA

---

## STATE CORPORATION COMMISSION

### Bureau of Insurance

**REGISTRAR'S NOTICE:** The Insurer Affiliation Survey is not being published. However, the survey may be accessed via the Internet at <http://www.naic.org/servlet/FSAffiliatesSu630>. A copy of the survey may also be viewed at the Virginia Code Commission, General Assembly Building, 2nd Floor, 910 Capitol Street, Richmond, Virginia 23219, during regular office hours.

October 21, 2002

#### Administrative Letter 2002-13

**TO: All domestic companies licensed as insurers in accordance with Chapter 10 or otherwise licensed, registered, listed or approved pursuant to Chapter 12, 26, 27, 42, 43, 44, 45, 46 or 51 of Title 38.2 of the Code of Virginia.**

#### RE: Insurer Affiliation Survey

The purpose of this administrative letter is to request domestic insurers and others to participate in a survey to identify insurance underwriters that are affiliated with banks and securities firms.

The survey, which was developed by the National Association of Insurance Commissioners' ("NAIC") Coordinating with Federal Regulators Working Group, conforms to an Annual Statement Interrogatory (Interrogatory) that will be effective in 2003. This Interrogatory is designed to capture information on affiliations between insurance underwriters and financial services companies. The Interrogatory will be used to update the information compiled from this initial survey, which will be made available to state insurance regulators and federal financial services agencies.

The NAIC is providing services to facilitate the data collection effort. A copy of the survey may be accessed via the Internet at: <http://www.naic.org/servlet/FSAffiliatesSu630>. A copy of the survey is also attached. The survey should be completed and submitted electronically to the NAIC, and a hard copy of the completed survey should be submitted to the Bureau of Insurance by **October 31, 2002**.

Questions concerning this administrative letter and submission of hard copies of the completed survey should be directed to Edward J. Buyalos, Jr., Financial Regulation Division, Bureau of Insurance, State Corporation Commission, P.O. Box 1157, Richmond, VA 23218, telephone (804) 371-9605.

/s/ Alfred W. Gross  
Commissioner of Insurance

## STATE LOTTERY DEPARTMENT

The following Director's Orders of the State Lottery Department were filed with the Virginia Registrar of Regulations on October 18, 2002. The orders may be viewed at the State Lottery Department, 900 E. Main Street, Richmond, Virginia or at the office of the Registrar of Regulations, 910 Capitol Street, 2nd Floor, Richmond, Virginia.

#### DIRECTOR'S ORDER NUMBER FORTY-SIX (02)

Virginia's Instant Game Lottery 531; "Millionaire Party II" Final Rules for Game Operation (effective 9/23/02).

#### DIRECTOR'S ORDER NUMBER FORTY-SEVEN (02)

Virginia's Instant Game Lottery 240; "Diamond Card" Final Rules for Game Operation (effective 9/30/02).

#### DIRECTOR'S ORDER NUMBER FORTY-EIGHT (02)

Virginia's Instant Game Lottery 527; "Money Talks" Final Rules for Game Operation (effective 9/30/02).

#### DIRECTOR'S ORDER NUMBER FORTY-NINE (02)

Virginia's Instant Game Lottery 528; "\$20,000 Cashword" Final Rules for Game Operation (effective 9/30/02).

#### DIRECTOR'S ORDER NUMBER FIFTY (02)

Virginia's Instant Game Lottery 535; "Season's Greetings" Final Rules for Game Operation (effective 9/30/02).

#### DIRECTOR'S ORDER NUMBER FIFTY-ONE (02)

Virginia's Instant Game Lottery 536; "Winter Action" Final Rules for Game Operation (effective 9/30/02).

#### DIRECTOR'S ORDER NUMBER FIFTY-FOUR (02)

Virginia's Instant Game Lottery 532; "Blazin' Eights" Final Rules for Game Operation (effective 10/11/02).

\* \* \* \* \*

#### DIRECTOR'S ORDER NUMBER FORTY-FIVE (02)

Certain Virginia Instant Game Lotteries; End of Games.

In accordance with the authority granted by §§ 2.2-4002 B(15) and 58.1-4006 A of the Code of Virginia, I hereby give notice that the following Virginia Lottery instant games will officially end at midnight on September 27, 2002:

Game 203 – Blackjack	Game 487 – Roll Them Bones
Game 208 – Kickin Cash	Game 489 – Slots of Cash
Game 211 – Fast 50s	Game 495 – 3 Card Cash
Game 213 – Sunny Money	Game 497 – Elvis
Game 220 – Wizard of Odds	Game 501 – Lottery Lucky Stars
Game 451 – \$100,000 Jackpot	Game 504 – Sweet Rewards
Game 481 – Lucky Jackpot	Game 505 – Whole Enchilada
Game 483 – Diamond Doubler	

The last day for lottery retailers to return for credit unsold tickets from any of these games will be November 1, 2002. The last day to redeem winning tickets for any of these games will be March 26, 2003, 180 days from the declared official end of the game. Claims for winning tickets from any of these

---

## General Notices/Errata

---

games will not be accepted after that date. Claims that are mailed and received in an envelope bearing a United States Postal Service postmark of March 26, 2003, will be deemed to have been received on time. This notice amplifies and conforms to the duly adopted State Lottery Board regulations for the conduct of instant game lotteries.

This order is available for inspection and copying during normal business hours at the State Lottery Department headquarters, 900 East Main Street, Richmond, Virginia; and at any State Lottery Department regional office. A copy may be requested by mail by writing to: Public Affairs Office, State Lottery Department, 900 East Main Street, Richmond, Virginia 23219.

This Director's Order becomes effective on the date of its signing and shall remain in full force and effect unless amended or rescinded by further Director's Order.

/s/ Richard G. Wilkinson  
Director, Lottery Operations  
Date: August 23, 2002

### DIRECTOR'S ORDER NUMBER FIFTY-THREE (02) Certain Virginia Instant Game Lotteries; End of Games.

In accordance with the authority granted by §§ 2.2-4002 B(15) and 58.1-4006 A of the Code of Virginia, I hereby give notice that the following Virginia Lottery instant games will officially end at midnight on November 15, 2002:

Game 186 – Double Doubler	Game 318 – Lots O' Spots Bingo
Game 210 – Congratulations	Game 469 – High Stakes
Game 215 – Hot Cards	Game 478 – Looking for the Green
Game 216 – Money Money Money	Game 490 – Hidden Treasure
Game 219 – Double Down	Game 493 – Virginia's Lucky 13th
Game 226 – Bank Shot	Game 508 – Fast Cash
Game 317 – Classic Bingo	

The last day for lottery retailers to return for credit unsold tickets from any of these games will be December 20, 2002. The last day to redeem winning tickets for any of these games will be May 14, 2003, 180 days from the declared official end of the game. Claims for winning tickets from any of these games will not be accepted after that date. Claims that are mailed and received in an envelope bearing a United States Postal Service postmark of May 14, 2003, will be deemed to have been received on time. This notice amplifies and conforms to the duly adopted State Lottery Board regulations for the conduct of instant game lotteries.

This order is available for inspection and copying during normal business hours at the State Lottery Department headquarters, 900 East Main Street, Richmond, Virginia; and at any State Lottery Department regional office. A copy may be requested by mail by writing to: Public Affairs Office, State Lottery Department, 900 East Main Street, Richmond, Virginia 23219.

This Director's Order becomes effective on the date of its signing and shall remain in full force and effect unless amended or rescinded by further Director's Order.

/s/ Richard G. Wilkinson  
Director, Lottery Operations  
Date: October 10, 2002

## BOARD OF PHYSICAL THERAPY

### Notice of Periodic Review of Regulations

**Review Announcement:** The Board of Physical Therapy within the Department of Health Professions is conducting a periodic review of 18 VAC 112-20, Regulations Governing the Practice of Physical Therapy.

#### Goals of Regulations:

1. To review methods for assuring continuing competency of licensed practitioners in physical therapy.
2. To update the practice requirements for physical therapists and physical therapist assistants.

If any member of the public would like to comment on these regulations, please send comments by December 18, 2002, to Elaine J. Yeatts, Agency Regulatory Coordinator, Department of Health Professions, 6603 West Broad Street, Richmond, VA 23230-1712. Comments may also be e-mailed to [elaine.yeatts@dhp.state.va.us](mailto:elaine.yeatts@dhp.state.va.us) or faxed to (804) 662-9114.

Regulations for physical therapy may be viewed on-line at [leg1.state.va.us/000/reg/TOC18112.htm#c0020](http://leg1.state.va.us/000/reg/TOC18112.htm#c0020), [www.townhall.state.va.us](http://www.townhall.state.va.us) or [www.dhp.state.va.us](http://www.dhp.state.va.us), or copies will be sent upon request.

## VIRGINIA CODE COMMISSION

### Notice to State Agencies

**Mailing Address:** Virginia Code Commission, 910 Capitol Street, General Assembly Building, 2nd Floor, Richmond, VA 23219, FAX (804) 692-0625.

### Forms for Filing Material for Publication in *The Virginia Register of Regulations*

All agencies are required to use the appropriate forms when furnishing material for publication in the Virginia Register of Regulations. The forms may be obtained from: Virginia Code Commission, 910 Capitol Street, General Assembly Building, 2nd Floor, Richmond, VA 23219, telephone (804) 786-3591.

**Internet:** Forms and other Virginia Register resources may be printed or downloaded from the Virginia Register web page: <http://register.state.va.us>

#### FORMS:

- NOTICE of INTENDED REGULATORY ACTION - RR01
- NOTICE of COMMENT PERIOD - RR02
- PROPOSED (Transmittal Sheet) - RR03
- FINAL (Transmittal Sheet) - RR04
- EMERGENCY (Transmittal Sheet) - RR05

NOTICE of MEETING - RR06  
AGENCY RESPONSE TO LEGISLATIVE OBJECTIONS -  
RR08  
PETITION FOR RULEMAKING - RR13

## ERRATA

### STATE CORPORATION COMMISSION

Title of Regulation: **20 VAC 5-312. Rules Governing Retail  
Access to Competitive Energy Services.**

Publication: 19:1 VA.R. 119-123 September 23, 2002

Correction to Final Regulation:

Page 122, 20 VAC 5-312-90 H 2, line 2, transpose "consumer"  
and "utility"

---

# CALENDAR OF EVENTS

---

## Symbol Key

- † Indicates entries since last publication of the *Virginia Register*  
♿ Location accessible to persons with disabilities  
☎ Teletype (TTY)/Voice Designation

### NOTICE

Only those meetings which are filed with the Registrar of Regulations by the filing deadline noted at the beginning of this publication are listed. Since some meetings are called on short notice, please be aware that this listing of meetings may be incomplete. Also, all meetings are subject to cancellation and the *Virginia Register* deadline may preclude a notice of such cancellation. If you are unable to find a meeting notice for an organization in which you are interested, please check the Commonwealth Calendar at [www.vipnet.org](http://www.vipnet.org) or contact the organization directly.

For additional information on open meetings and public hearings held by the standing committees of the legislature during the interim, please call Legislative Information at (804) 698-1500 or Senate Information and Constituent Services at (804) 698-7410 or (804) 698-7419/TTY☎, or visit the General Assembly web site's Legislative Information System (<http://leg1.state.va.us/lis.htm>) and select "Meetings."

VIRGINIA CODE COMMISSION

## EXECUTIVE

### BOARD OF ACCOUNTANCY

**November 22, 2002 - 10 a.m.** -- Open Meeting  
Courtyard-Marriott Richmond West, 6400 West Broad Street, Richmond, Virginia.♿ (Interpreter for the deaf provided upon request)

A meeting to discuss matters requiring board action including regulatory review. A public comment period will be held at the beginning of the meeting.

**Contact:** Nancy Taylor Feldman, Executive Director, Board of Accountancy, 3600 W Broad St., Suite 696 Richmond, VA 23230-4916, telephone (804) 367-8505, FAX (804) 367-2174, (804) 367-9753/TTY☎, e-mail [boa@boa.state.va.us](mailto:boa@boa.state.va.us).

### STATE BOARD OF AGRICULTURE AND CONSUMER SERVICES

**March 13, 2003 - 10 a.m.** -- Public Hearing  
Washington Building, 1100 Bank Street, 2nd Floor Board Room, Richmond, Virginia.

NOTE: EXTENSION OF PUBLIC COMMENT PERIOD  
**January 15, 2003** -- Public comments may be submitted until this date.

Notice is hereby given in accordance with § 2.2-4007 of the Code of Virginia that the State Board of Agriculture and Consumer Services intends to amend regulations entitled: **2 VAC 5-320. Rules and Regulations for the Enforcement of the Endangered Plant and Insect Species Act.** The purpose of the proposed action is to review the regulation for effectiveness and continued need, including the following: amending the regulation to (i) remove the currently named plants that are no longer considered globally rare and (ii) add those threatened or endangered plant and insect species that are considered rare both globally and in Virginia.

Statutory Authority: § 3.1-1025 of the Code of Virginia.

**Contact:** Frank M. Fulgham, Program Manager, Department of Agriculture and Consumer Services, 1100 Bank St., Room 703, Richmond, VA 23219, telephone (804) 786-3515, FAX (804) 371-7793 or e-mail [ffulgham@vdacs.state.va.us](mailto:ffulgham@vdacs.state.va.us).

\*\*\*\*\*

**March 13, 2003 - 10 a.m.** -- Public Hearing  
Washington Building, 1100 Bank Street, 2nd Floor Board Room, Richmond, Virginia.

NOTE: EXTENSION OF PUBLIC COMMENT PERIOD  
**January 15, 2003** -- Public comments may be submitted until this date.

Notice is hereby given in accordance with § 2.2-4007 of the Code of Virginia that the State Board of Agriculture and Consumer Services intends to amend regulations entitled: **2 VAC 5-360. Regulations for the Enforcement of the Virginia Commercial Feed Act.** The purpose of the proposed action is to amend the current regulation to incorporate the changes made to the commercial feed industry standards by the Association of American Feed Control Officials in the last decade and statutory changes made to Virginia's Commercial Feed Law in 1994.

Statutory Authority: § 3.1-828.4 of the Code of Virginia.

**Contact:** J. Alan Rogers, Program Manager, Department of Agriculture and Consumer Services, 1100 Bank St., Room 402, Richmond, VA 23219, telephone (804) 786-2476, FAX (804) 371-1571 or e-mail [jrogers@vdacs.state.va.us](mailto:jrogers@vdacs.state.va.us).

\*\*\*\*\*

**March 13, 2003 - 10 a.m.** -- Public Hearing  
Washington Building, 1100 Bank Street, 2nd Floor Board Room, Richmond, Virginia.

**December 9, 2002** -- Public comments may be submitted until this date.

Notice is hereby given in accordance with § 2.2-4007 of the Code of Virginia that the State Board of Agriculture and Consumer Services intends to amend regulations entitled:

**2 VAC 5-440. Rules and Regulations for Enforcement of the Virginia Pest Law - Cotton Boll Weevil Quarantine.**

The purpose of the proposed regulatory action is to amend the regulation to (i) establish the fixed date of July 1 as the official reporting and payment date for acreage assessment, (ii) reduce penalties assessed on farm operators for the late payment or nonpayment of fees from \$10 to \$5.00 per acre, and (iii) eliminate the mandate for destruction of the cotton crop for nonpayment of fees and assessments by farm operators.

Statutory Authority: § 3.1-188.23 of the Code of Virginia.

**Contact:** Frank M. Fulgham, Program Manager, Department of Agriculture and Consumer Services, 1100 Bank St., Room 703, Richmond, VA 23219, telephone (804) 786-3515, FAX (804) 371-7793 or e-mail [fulgham@vdacs.state.va.us](mailto:fulgham@vdacs.state.va.us).

\* \* \* \* \*

**March 13, 2003 - 10 a.m.** -- Public Hearing  
Washington Building, 1100 Bank Street, 2nd Floor Board Room, Richmond, Virginia.

**December 9, 2002** -- Public comments may be submitted until this date.

Notice is hereby given in accordance with § 2.2-4007 of the Code of Virginia that the State Board of Agriculture and Consumer Services intends to **repeal** regulations entitled: **2 VAC 5-500. Rules and Regulations Governing the Cooling, Storing, Sampling, and Transporting of Milk or Milk Samples from the Farm to the Processing Plant or Laboratory** and **adopt** regulations entitled: **2 VAC 5-501. Regulations Governing the Cooling, Storing, Sampling, and Transporting of Milk.** The purpose of the proposed action is to (i) make the regulations applicable to the milk of goats, sheep, water buffalo, and other mammals if the milk or dairy products are intended for human consumption and (ii) require permits for milk pickup trucks, milk transport tanks, laboratories, persons testing milk samples for pay purposes, persons collecting official milk samples in dairy plants, and milk tank truck cleaning facilities.

Statutory Authority: §§ 3.1-530.1, 3.1-530.2, 3.1-535, and 3.1-535.1 of the Code of Virginia.

**Contact:** John A. Beers, Program Supervisor, Department of Agriculture and Consumer Services, 1100 Bank St., Room 505, Richmond, VA 23219, telephone (804) 786-1453, FAX (804) 371-7792 or e-mail [jbeers@vdacs.state.va.us](mailto:jbeers@vdacs.state.va.us).

\* \* \* \* \*

**March 13, 2003 - 10 a.m.** -- Public Hearing  
Washington Building, 1100 Bank Street, 2nd Floor Board Room, Richmond, Virginia.

**December 9, 2002** -- Public comments may be submitted until this date.

Notice is hereby given in accordance with § 2.2-4007 of the Code of Virginia that the State Board of Agriculture and Consumer Services intends to **repeal** regulations entitled: **2 VAC 5-530. Rules and Regulations G**

**overning the Production, Handling and Processing of Milk for Manufacturing Purposes and Establishing Minimum Standards for Certain Dairy Products to be Used for Human Food** and **adopt** regulations entitled: **2 VAC 5-531. Regulations Governing Milk for Manufacturing Purposes.**

The purpose of the proposed action is to adopt regulations consistent with the most recent USDA recommendations on milk for manufacturing purposes and regulate manufactured milk and milk products from goats, sheep, water buffalo and other noncow sources in the interest of public health and safety.

Statutory Authority: §§ 3.1-530.1 and 3.1-530.2 of the Code of Virginia.

**Contact:** John A. Beers, Program Supervisor, Department of Agriculture and Consumer Services, 1100 Bank St., Room 505, Richmond, VA 23219, telephone (804) 786-1453, FAX (804) 371-7792 or e-mail [jbeers@vdacs.state.va.us](mailto:jbeers@vdacs.state.va.us).

## DEPARTMENT OF AGRICULTURE AND CONSUMER SERVICES

### Farmland Preservation Task Force

† **November 19, 2002 - 10 a.m.** -- Open Meeting  
Virginia Farm Bureau Federation Headquarters, 12580 West Creek Parkway, Richmond, Virginia. 

The Farmland Preservation Task Force has the responsibility of developing a proposed Purchase of Development Rights (PDR) Program for the state and at this session the task force will work on the program. Any person who needs any accommodation in order to participate at the meeting should contact William P. Dickinson, Jr. at least five days before the meeting date so that suitable arrangements can be made.

**Contact:** William P. Dickinson, Jr., Assistant Commissioner, Department of Agriculture and Consumer Services, P.O. Box 1163, Richmond, VA 23218, telephone (804) 786-3502, FAX (804) 371-2945, toll-free (800) 828-1120, e-mail [wdickinson@vdacs.state.va.us](mailto:wdickinson@vdacs.state.va.us).

## ALCOHOLIC BEVERAGE CONTROL BOARD

**November 25, 2002 - 9 a.m.** -- Open Meeting  
**December 9, 2002 - 9 a.m.** -- Open Meeting  
**December 23, 2002 - 9 a.m.** -- Open Meeting  
Department of Alcoholic Beverage Control, 2901 Hermitage Road, Richmond, Virginia. 

A meeting to discuss reports and activities from staff members and other board business.

**Contact:** W. Curtis Coleburn, Secretary to the Board, Alcoholic Beverage Control Board, 2901 Hermitage Rd., P.O. Box 27491, Richmond, VA 23261, telephone (804) 213-4409, FAX (804) 213-4442.

---

# Calendar of Events

---

## BOARD FOR ARCHITECTS, PROFESSIONAL ENGINEERS, LAND SURVEYORS, CERTIFIED INTERIOR DESIGNERS AND LANDSCAPE ARCHITECTS

**December 11, 2002 - 9 a.m.** -- Open Meeting  
Department of Professional and Occupational Regulation,  
3600 West Broad Street, Richmond, Virginia. 

A meeting to conduct board business.

**Contact:** Mark N. Courtney, Assistant Director, Board for Architects, Professional Engineers, Land Surveyors, Certified Interior Designers and Landscape Architects, 3600 W. Broad St., Richmond, VA 23230, telephone (804) 367-8514, FAX (804) 367-2475, (804) 367-9753/TTY , e-mail apels@dpor.state.va.us.

## ART AND ARCHITECTURAL REVIEW BOARD

**December 6, 2002 - 10 a.m.** -- Open Meeting  
Virginia War Memorial, 601 South Belvidere Street,  
Richmond, Virginia.  (Interpreter for the deaf provided upon request)

A monthly meeting to review projects submitted by state agencies. AARB submittal forms and submittal instructions can be downloaded by visiting the DGS forms center at [www.dgs.state.va.us](http://www.dgs.state.va.us). Request submittal form DGS-30-905 or submittal instructions form DGS-30-906.

**Contact:** Richard L. Ford, AIA, Chairman, Art and Architectural Review Board, 1011 E. Main St., Room 221, Richmond, VA 23219, telephone (804) 643-1977, FAX (804) 643-1981, (804) 786-6152/TTY 

## DEPARTMENT FOR THE BLIND AND VISION IMPAIRED

### Statewide Rehabilitation Council for the Blind

**December 7, 2002 - 10 a.m.** -- Open Meeting  
Administrative Headquarters, 397 Azalea Avenue, Richmond,  
Virginia.  (Interpreter for the deaf provided upon request)

A quarterly meeting to advise the department for the blind and vision impaired on matters related to vocational rehabilitation services for the blind and visually impaired citizens of the Commonwealth.

**Contact:** James G. Taylor, Vocational Rehabilitation Program Director, Department for the Blind and Vision Impaired, 397 Azalea Ave., Richmond VA 23227, telephone (804) 371-3111, FAX (804) 371-3390, toll-free (800) 622-2155, (804) 371-3140/TTY , e-mail [taylorjg@dbvi.state.va.us](mailto:taylorjg@dbvi.state.va.us).

## CHESAPEAKE BAY LOCAL ASSISTANCE BOARD

† **December 9, 2002 - 10 a.m.** -- Open Meeting  
James Monroe Building, 101 North 14th Street, Conference Room C, Main Level, Richmond, Virginia.  (Interpreter for the deaf provided upon request)

The board will conduct general business, including review of local Chesapeake Bay Preservation Area programs. The board will consider approval of required amendments to their Public Participation Guidelines, 9 VAC 10-10, approval of the guidance document entitled "Agriculture: Soil and Water Quality Conservation Assessment," and will discuss other policy related issues. Public comment will be received.

**Contact:** Carolyn J. Elliott, Administrative Assistant, Chesapeake Bay Local Assistance Board, James Monroe Bldg., 101 N. 14th St., 17th Floor, Richmond, VA 23219, telephone (804) 371-7505, FAX (804) 225-3447, toll-free (800) 243-7229, (800) 243-7229/TTY , e-mail [celliot@cblad.state.va.us](mailto:celliot@cblad.state.va.us).

## CHILD DAY-CARE COUNCIL

† **November 19, 2002 - 8:30 a.m.** -- Open Meeting  
Theater Row Building, 730 East Broad Street, Richmond,  
Virginia.  (Interpreter for the deaf provided upon request)

New member orientation in the 7th Floor Conference Room. Starting at 1:30 p.m. in Conference Room 1, the council will meet to discuss issues and concerns that impact child day centers, camps, school-age programs and preschools/nursery schools. Public comment will be received at 3 p.m. Please call ahead for possible changes in meeting time.

**Contact:** Arlene Kasper, Program Development Consultant, Department of Social Services, 730 E. Broad St., Richmond, VA 23219-1849, telephone (804) 692-1791, FAX (804) 692-2370, (800) 828-1120/TTY 

## STATE BOARD FOR COMMUNITY COLLEGES

**November 20, 2002 - 1:30 p.m.** -- Open Meeting  
Virginia Community College System, 101 North 14th Street,  
15th Floor, Richmond, Virginia.  (Interpreter for the deaf provided upon request)

Meetings of the Academic and Student Affairs, the Audit, and the Budget and Finance Committees.

**Contact:** D. Susan Hayden, Public Relations Manager, State Board for Community Colleges, 101 N. 14th St., 15th Floor, Richmond, VA 23219, telephone (804) 819-4961, FAX (804) 819-4768, (804) 371-8504/TTY 

**November 21, 2002 - 9 a.m.** -- Open Meeting  
Virginia Community College System, Godwin-Hamel Board Room, 101 North 14th Street, 15th Floor, Richmond, Virginia.  (Interpreter for the deaf provided upon request)

A regular business meeting. Public comment will be received at the beginning of the meeting.

**Contact:** D. Susan Hayden, Public Relations Manager, State Board for Community Colleges, 101 N. 14th St., 15th Floor, Richmond, VA 23219, telephone (804) 819-4961, FAX (804) 819-4768, (804) 371-8504/TTY 

## COMPENSATION BOARD

**November 26, 2002 - 11 a.m.** -- Open Meeting  
Compensation Board, 202 North 9th Street, 10th Floor,  
Richmond, Virginia. 

A monthly board meeting.

**Contact:** Cindy P. Waddell, Administrative Staff Assistant,  
Compensation Board, P.O. Box 710, Richmond, VA 23218,  
telephone (804) 786-0786, FAX (804) 371-0235, e-mail  
cwaddell@scb.state.va.us.

## DEPARTMENT OF CONSERVATION AND RECREATION

### Virginia Cave Board

† **November 23, 2002 - 11 a.m.** -- Open Meeting  
Department of Conservation and Recreation, Shenandoah  
Watershed Office, 44 Sangers Lane, Suite 102, Staunton,  
Virginia.  (Interpreter for the deaf provided upon request)

A regular business meeting. Committee meetings will begin  
at 11 a.m., and the regular board meeting will begin at 1  
p.m.

**Contact:** Larry Smith, Natural Area Protection Manager,  
Department of Conservation and Recreation, 203 Governor  
St., Richmond, VA 23219, telephone (804) 371-6205, FAX  
(804) 371-2674, e-mail lsmith@dcr.state.va.us.

### Chippokes Plantation Farm Foundation Board

**November 25, 2002 - 2 p.m.** -- Open Meeting  
Chippokes Farm and Forestry Museum Workshop Building,  
Chippokes Plantation State Park, Surry, Virginia.   
(Interpreter for the deaf provided upon request)

A regular business meeting of the Board of Trustees.

**Contact:** Donna Steward Sharits, Development Manager,  
Department of Conservation and Recreation, Monroe Bldg.,  
101 N. 14th St., 11th Floor, Richmond, VA 23219, telephone  
(804) 786-3692, FAX (804) 371-8500, e-mail  
dsharits@dcr.state.va.us.

### Falls of the James Scenic River Advisory Board

**December 5, 2002 - Noon** -- Open Meeting  
Richmond City Hall, 900 East Broad Street, 5th Floor  
Conference Room, Richmond, Virginia.  (Interpreter for the  
deaf provided upon request)

A discussion of river issues.

**Contact:** Richard G. Gibbons, Environmental Program  
Manager, Department of Conservation and Recreation, 203  
Governor St., Suite 326, Richmond, VA 23219, telephone  
(804) 786-4132, FAX (804) 371-7899, e-mail  
rgibbons@dcr.state.va.us.

## Virginia Soil and Water Conservation Board

† **December 11, 2002 - 9:30 a.m.** -- Open Meeting  
Hotel Roanoke, Roanoke, Virginia.  (Interpreter for the deaf  
provided upon request)

A general business meeting and joint meeting with the  
Virginia Association of Soil and Water Conservation  
Districts Board of Directors.

**Contact:** Leon E. App, Acting Deputy Director, Department of  
Conservation and Recreation, 203 Governor St., Suite 302,  
Richmond, VA 23219, telephone (804) 786-6124, FAX (804)  
786-6141, e-mail leonapp@dcr.state.va.us.

## BOARD FOR CONTRACTORS

**December 4, 2002 - 9 a.m.** -- Open Meeting  
† **January 22, 2003 - 9 a.m.** -- Open Meeting  
Department of Professional and Occupational Regulation,  
3600 West Broad Street, Richmond, Virginia.  (Interpreter for the  
deaf provided upon request)

A regularly scheduled meeting to address policy and  
procedural issues; review and render decisions on  
applications for contractors' licenses, and review and render  
case decisions on matured complaints against licensees.  
The meeting is open to the public; however, a portion of the  
board's business may be discussed in closed session.

**Contact:** Eric L. Olson, Assistant Director, Board for  
Contractors, 3600 W. Broad St., Richmond, VA 23230,  
telephone (804) 367-2785, FAX (804) 367-2474, (804) 367-  
9753/TTY , e-mail olsone@dpor.state.va.us.

## BOARD OF COUNSELING

† **November 21, 2002 - 9 a.m.** -- Open Meeting  
Department of Health Professions, 6606 West Broad Street,  
5th Floor, Conference Room 4, Richmond, Virginia. 

The Credentials Committee will consider matters related to  
the credentials of candidates for licensure or certification.  
Public comment will be received as appropriate on the  
agenda.

**Contact:** Evelyn B. Brown, Executive Director, Board of  
Counseling, Southern States Bldg., 6606 W. Broad St., 4th  
Floor, Richmond, VA 23230-1717, telephone (804) 662-9912,  
FAX (804) 662-9943, (804) 662-7197/TTY , e-mail  
evelyn.brown@dhp.state.va.us.

† **November 21, 2002 - Noon** -- Open Meeting  
Department of Health Professions, 6606 West Broad Street,  
5th Floor, Conference Room 1, Richmond, Virginia. 

The Regulatory Committee will consider regulatory issues,  
including the DPB analysis of regulations for substance  
abuse counselors and practitioners and the continuing  
education requirements for all licensees. Public comment  
will be received at the beginning of the meeting.

**Contact:** Evelyn B. Brown, Executive Director, Board of  
Counseling, Southern States Bldg., 6606 W. Broad St., 4th  
Floor, Richmond, VA 23230-1717, telephone (804) 662-9912,

---

## Calendar of Events

---

FAX (804) 662-9943, (804) 662-7197/TTY ☎, e-mail evelyn.brown@dhp.state.va.us.

† **November 22, 2002 - 10 a.m.** -- Open Meeting  
Department of Health Professions, 6606 West Broad Street, 5th Floor, Conference Room 1, Richmond, Virginia. ♿

The board will receive reports from standing committees and consider regulatory and disciplinary matters as may be presented on the agenda. Public comment will be received at the beginning of the meeting.

**Contact:** Evelyn B. Brown, Executive Director, Board of Counseling, Southern States Bldg., 6606 W. Broad St., 4th Floor, Richmond, VA 23230-1717, telephone (804) 662-9912, FAX (804) 662-9943, (804) 662-7197/TTY ☎, e-mail evelyn.brown@dhp.state.va.us.

† **December 6, 2002 - 10 a.m.** -- Open Meeting  
Department of Health Professions, 6603 West Broad Street, 5th Floor, Richmond, Virginia. ♿

The Special Conference Committee will convene for an informal conference to hear possible violations of the laws and regulations governing the practice of counseling. No public comment will be heard.

**Contact:** Evelyn B. Brown, Executive Director, Board of Counseling, 6603 W. Broad St., 5th Floor, Richmond, VA 23230-1712, telephone (804) 662-7328, FAX (804) 662-7250, (804) 662-7197/TTY ☎, e-mail coun@dhp.state.va.us.

### BOARD OF DENTISTRY

**November 22, 2002 - 9 a.m.** -- Open Meeting  
† **December 6, 2002 - 2 p.m.** -- Open Meeting  
Department of Health Professions, 6603 West Broad Street, 5th Floor, Richmond, Virginia. ♿

The Special Conference Committee will meet to hold informal hearings. There will not be a public comment period.

**Contact:** Cheri Emma-Leigh, Operations Manager, Department of Health Professions, 6606 W. Broad St., 4th Floor, Richmond, VA, telephone (804) 662-9906, FAX (804) 662-7246, (804) 662-7197/TTY ☎, e-mail CEmma-Leigh@dhp.state.va.us.

† **December 4, 2002 - 9 a.m.** -- Open Meeting  
Department of Health Professions, 6606 West Broad Street, 5th Floor, Conference Room 3, Richmond, Virginia. ♿

The board will adopt proposed regulations for anesthesia and other items pursuant to its periodic review, final regulations for a fee increase and for oral and maxillofacial surgeons. Other regulatory and disciplinary matters may be considered as presented on the agenda. Public comment will be received at the beginning of the meeting.

**Contact:** Sandra Reen, Executive Director, Board of Dentistry, Southern States Bldg., 6606 W. Broad St., 4th Floor, Richmond, VA 23230-1717, telephone (804) 662-9906, FAX (804) 662-9943, (804) 662-7197/TTY ☎, e-mail sandra\_reen@dhp.state.va.us.

† **December 6, 2002 - 8:30 a.m.** -- Open Meeting  
Department of Health Professions, 6603 West Broad Street, 5th Floor, Richmond, Virginia. ♿

A panel of the board will meet to hold formal hearings. The meeting is open to the public, however, there will not be a public comment period.

**Contact:** Cheri Emma-Leigh, Operations Manager, Board of Dentistry, 6606 W. Broad St., 4th Floor, Richmond, VA, telephone (804) 662-9906, FAX (804) 662-7246, (804) 662-7197/TTY ☎, e-mail CEmma-Leigh@dhp.state.va.us.

### DESIGN-BUILD/CONSTRUCTION MANAGEMENT REVIEW BOARD

**November 21, 2002 - 11 a.m.** -- Open Meeting  
**December 19, 2002 - 11 a.m.** -- Open Meeting  
Virginia War Memorial, 601 South Belvidere Street, Auditorium, Richmond, Virginia. ♿ (Interpreter for the deaf provided upon request)

A meeting to review requests submitted by localities to use design-build or construction management-type contracts. Contact the Division of Engineering and Buildings to confirm the meeting. Board rules and regulations can be obtained online at [www.dgs.state.va.us](http://www.dgs.state.va.us) under the DGS Forms, Form DGS-30-904.

**Contact:** Freddie M. Adcock, Administrative Assistant, Department of General Services, 805 E. Broad St., Room 101, Richmond, VA 23219, telephone (804) 786-3263, FAX (804) 371-7934, (804) 786-6152/TTY ☎, e-mail fadcock@dgs.state.va.us.

### VIRGINIA ECONOMIC DEVELOPMENT PARTNERSHIP

† **December 3, 2002 - 10:30 a.m.** -- Open Meeting  
Virginia Economic Development Partnership, 901 East Byrd Street, West Tower, 19th Floor, Richmond, Virginia. ♿

A meeting of the Board of Directors to focus on issues pertaining to the Virginia Economic Development Partnership.

**Contact:** Kimberly M. Ellett, Senior Executive Assistant, Virginia Economic Development Partnership, P.O. Box 798, Richmond, VA 23218, telephone (804) 371-8108, FAX (804) 371-8112, e-mail kellett@yesvirginia.org.

### BOARD OF EDUCATION

**November 18, 2002 - 9 a.m.** -- Open Meeting  
**January 27, 2003 - 9 a.m.** -- Open Meeting  
Hilton Garden Inn, Richmond Innsbrook, 4050 Cox Road, Glen Allen, Virginia. ♿ (Interpreter for the deaf provided upon request)

A meeting of the Advisory Board for Teacher Education and Licensure. Persons requesting the services of an interpreter for the deaf should do so at least 72 hours in advance. This



will be a work session and public comment will not be received.

**Contact:** Dr. Margaret N. Roberts, Office of Policy and Public Affairs, Department of Education, P.O. Box 2120, 101 N. 14th St., 25th Floor, Richmond, VA 23219, telephone (804) 225-2540, FAX (804) 225-2524, e-mail mroberts@mail.vak12ed.edu.

**November 20, 2002 - 9 a.m.** -- Open Meeting  
General Assembly Building, 9th and Broad Streets, Senate Room B, Richmond, Virginia.  (Interpreter for the deaf provided upon request)

† **January 6, 2003 - 9 a.m.** -- Open Meeting  
Location to be announced.

A regular business meeting of the board. Persons who wish to speak or who require the services of an interpreter for the deaf should contact the agency in advance. Public comment will be received.

**Contact:** Dr. Margaret N. Roberts, Office of Policy and Public Affairs, Department of Education, P.O. Box 2120, James Monroe Bldg., 101 N. 14th St., 25th Floor, Richmond, VA 23219, telephone (804) 225-2540, FAX (804) 225-2524, e-mail mroberts@mail.vak12ed.edu.

\*\*\*\*\*

**November 25, 2002** - Public comments may be submitted until this date.

Notice is hereby given in accordance with § 2.2-4007 of the Code of Virginia that the Board of Education intends to amend regulations entitled: **8 VAC 20-70. Regulations Governing Pupil Transportation Including Minimum Standards for School Buses in Virginia.** The current regulations are being amended in order to comport with federal and state laws and regulations.

Statutory Authority: §§ 2.2-16, 2.2-177 and 2.2-178 of the Code of Virginia.

**Contact:** June Eanes, Director of Pupil Transportation, Department of Education, P.O. Box 2120, Richmond, VA 23219, telephone (804) 225-2924, FAX (804) 225-2524 or e-mail jeanes@mail.vak12ed.edu.

† **December 2, 2002 - 7 p.m.** -- Public Hearing  
Brosville Middle School, 195 Bulldog Lane, Auditorium, Danville, Virginia.  (Interpreter for the deaf provided upon request)

† **December 2, 2002 - 7 p.m.** -- Public Hearing  
Fairfax High School, 3500 Old Lee Highway, Auditorium, Fairfax, Virginia.  (Interpreter for the deaf provided upon request)

† **December 2, 2002 - 7 p.m.** -- Public Hearing  
Lafayette High School, 4460 Longhill Road, Lecture Hall, Williamsburg, Virginia.  (Interpreter for the deaf provided upon request)

† **December 2, 2002 - 7 p.m.** -- Public Hearing  
Marion High School, 848 Stage Street, Auditorium, Marion, Virginia.  (Interpreter for the deaf provided upon request)

A public hearing to receive comment on the proposed revisions to the Science SOL. Speakers will be limited to three minutes each. Persons requesting the services of an interpreter for the deaf are asked to do so at least 72 hours in advance.

**Contact:** Dr. Margaret N. Roberts, Office of Policy and Public Affairs, Department of Education, P.O. Box 2120, 101 N. 14th St., 25th Floor, Richmond, VA 23219, telephone (804) 225-2540, FAX (804) 225-2524, e-mail mroberts@mail.vak12ed.edu.

**December 4, 2002 - 9 a.m.** -- Open Meeting  
State Capitol, House Room 2, Richmond, Virginia.  (Interpreter for the deaf provided upon request)

A working session of the Committee to Implement NCLB. Public comment will not be received. Persons requesting services of an interpreter for the deaf are asked to do so in advance.

**Contact:** Dr. Margaret N. Roberts, Office of Policy and Public Affairs, Department of Education, P.O. Box 2120, 101 N. 14th St., 25th Floor, Richmond, VA 23219, telephone (804) 225-2540, FAX (804) 225-2524, e-mail mroberts@mail.vak12ed.edu.

**January 9, 2003 - 8:30 a.m.** -- Open Meeting

**January 10, 2003 - 8:30 a.m.** -- Open Meeting  
Radisson Hotel Historic Richmond, 301 West Franklin Street, Richmond, Virginia.  (Interpreter for the deaf provided upon request)

A working session of the State Special Education Advisory Committee. Public comment will not be received. Persons requesting the services of an interpreter for the deaf should do so in advance.

**Contact:** Dr. Margaret N. Roberts, Office of Policy and Public Affairs, Department of Education, P.O. Box 2120, James Monroe Bldg., 101 N. 14th St., 25th Floor, Richmond, VA 23219, telephone (804) 225-2540, FAX (804) 225-2524, e-mail mroberts@mail.vak12ed.edu.

## LOCAL EMERGENCY PLANNING COMMITTEE - WINCHESTER

† **December 4, 2002 - 3 p.m.** -- Open Meeting  
Timbrook Public Safety Center, 231 East Piccadilly Street, Winchester, Virginia.

A regular meeting.

**Contact:** L. A. Miller, Fire and Rescue Chief, Local Emergency Planning Committee, Winchester Fire and Rescue Department, 231 E. Piccadilly St., Winchester, VA 22601, telephone (540) 662-2298.

## DEPARTMENT OF ENVIRONMENTAL QUALITY

**November 19, 2002 - 9 a.m.** -- Open Meeting  
Department of Environmental Quality, 629 East Main Street, First Floor Conference Room, Richmond, Virginia. 

---

## Calendar of Events

---

A meeting of the Ground Water Protection Steering Committee, an interagency advisory committee formed to stimulate, strengthen and coordinate ground water protection activities in the Commonwealth. For more information and an agenda contact Mary Ann Massie.

**Contact:** Mary Ann Massie, Department of Environmental Quality, P.O. Box 10009, Richmond, VA 23240, telephone (804) 698-4042, e-mail mamassie@deq.state.va.us.

**November 20, 2002 - 7 p.m.** -- Open Meeting  
Lovettsville Room, Loudoun County Government Center, 1 Harrison Street, S.E., Leesburg, Virginia. 

Public meetings on the development of the Goose Creek Watershed bacteria TMDL. The public comment period ends on December 13, 2002.

**Contact:** Katherine Bennett, Department of Environmental Quality, 13901 Crown Court, Woodbridge, VA 22193, telephone (703) 583-3896, e-mail kebennett@deq.state.va.us.

### VIRGINIA FIRE SERVICES BOARD

**† November 26, 2002 - 8 a.m.** -- Open Meeting  
Chesterfield Fire Department Training Center, Eanes Pittman Public Safety Training Center, 6610 Public Safety Way, Chesterfield, Virginia.  (Interpreter for the deaf provided upon request)

Please contact Christy King for details.

**Contact:** Christy L. King, Clerk, Virginia Fire Services Board, 101 N. 14th St., 18th Floor, Richmond, VA 23219, telephone (804) 371-0220, FAX (804) 371-0219, e-mail cking@vdfp.state.va.us.

**† December 5, 2002 - 9 a.m.** -- Open Meeting  
Roanoke Valley Fire/EMS Training Center, 1220 Kessler Mill Road, Salem, Virginia.  (Interpreter for the deaf provided upon request)

Meetings of the following committees:  
Fire Education and Training - 9 a.m.  
Fire Prevention and Control - 9 a.m.  
Administration and Policy - 10 minutes after conclusion of Fire Education and Training Committee  
Finance - 10 minutes after conclusion of Fire Prevention and Control Committee and Administration and Policy Committees

**Contact:** Christy L. King, Clerk, Virginia Fire Services Board, 101 N. 14th St., 18th Floor, Richmond, VA 23219, telephone (804) 371-0220, FAX (804) 371-0219, e-mail cking@vdfp.state.va.us.

**† December 6, 2002 - 9 a.m.** -- Open Meeting  
Roanoke Valley Fire/EMS Training Center, 1220 Kessler Mill Road, Salem, Virginia.  (Interpreter for the deaf provided upon request)

Contact Christy King for details.

**Contact:** Christy L. King, Clerk, Virginia Fire Services Board, 101 N. 14th St., 18th Floor, Richmond, VA 23219, telephone

(804) 371-0220, FAX (804) 371-0219, e-mail cking@vdfp.state.va.us.

### BOARD OF FUNERAL DIRECTORS AND EMBALMERS

**† November 19, 2002 - 9 a.m.** -- Open Meeting  
Department of Health Professions, 6606 West Broad Street, 5th Floor, Conference Room 1, Richmond, Virginia. 

The Legislative/Regulatory Committee will discuss regulatory and legislative matters as may be presented on the agenda. Public comment will be received at the beginning of the meeting.

**Contact:** Elizabeth Young, Executive Director, Board of Funeral Directors and Embalmers, 6606 W. Broad St., 4th Floor, Richmond, VA 23230, telephone (804) 662-9907, FAX (804) 662-9523, (804) 662-7197/TTY , e-mail elizabeth.young@dhp.state.va.us.

NOTE: CHANGE IN MEETING DATE AND TIME

**† November 20, 2002 - 9 a.m.** -- Open Meeting  
Department of Health Professions, 6606 West Broad Street, 4th Floor, Richmond, Virginia. 

A meeting to hear possible violations of the laws and regulations governing the practice of funeral service previously scheduled for November 19, 2002.

**Contact:** Elizabeth Young, Executive Director, Board of Funeral Directors and Embalmers, 6606 W. Broad St., 4th Floor, Richmond, VA 23230-1717, telephone (804) 662-9907, FAX (804) 662-9523, (804) 662-7197/TTY , e-mail elizabeth.young@dhp.state.va.us.

**December 3, 2002 - 9 a.m.** -- Open Meeting  
Department of Health Professions, 6603 West Broad Street, 5th Floor, Richmond, Virginia. 

A general business meeting, including disciplinary and regulatory matters as may be presented on the agenda. Public comment will be received at the beginning of the meeting.

**Contact:** Elizabeth Young, Executive Director, Board of Funeral Directors and Embalmers, 6606 W. Broad St., 4th Floor, Richmond, VA 23230, telephone (804) 662-9907, FAX (804) 662-9523, (804) 662-7197/TTY , e-mail elizabeth.young@dhp.state.va.us.

### CHARITABLE GAMING COMMISSION

**December 4, 2002 - 10 a.m.** -- Open Meeting  
James Monroe Building, 101 North 14th Street, First Floor, Conference Room E, Richmond, Virginia. 

A meeting to discuss standard agenda items.

**Contact:** Frances C. Jones, Administrative Staff Assistant, Charitable Gaming Commission, 101 N. 14th St., 17th Floor, Richmond, VA 23219, telephone (804) 786-3014, FAX (804) 786-1079, e-mail jones@cgc.state.va.us.

## GEORGE MASON UNIVERSITY

**November 21, 2002 - 9 a.m.** -- Open Meeting  
**January 30, 2003 - 9 a.m.** -- Open Meeting  
George Mason University, Mason Hall, Lower Level, Fairfax, Virginia. ☎

A meeting of the Board of Visitors. Agenda to be announced.

**Contact:** Mary Roper, Secretary Pro Tem, George Mason University, MSN 3A1, 4400 University Dr., Fairfax, VA 22030, telephone (703) 993-8703, FAX (703) 993-8707, e-mail mroper@gmu.edu.

## GOVERNOR'S COMMISSION ON EFFICIENCY AND EFFECTIVENESS

† **November 26, 2002 - 10 a.m.** -- Open Meeting  
General Assembly Building, 9th and Broad Streets, House Room D, Richmond, Virginia. ☎

A full commission meeting.

**Contact:** Kelly Dalch, Office of Governor, State Capitol, 3rd Floor, Richmond, VA 23219, telephone (804) 786-2211.

**December 5, 2002 - 2 p.m.** -- Public Hearing  
General Assembly Building, 9th and Broad Streets, Senate Room B, Richmond, Virginia. ☎

A public hearing of the Governor's Commission on Efficiency and Effectiveness.

**Contact:** Kelly Dalch, Office of the Governor, State Capitol, 3rd Floor, Richmond, VA 23219, telephone (804) 786-2211.

## STATE BOARD OF HEALTH

**January 6, 2003** - Public comments may be submitted until this date.

Notice is hereby given in accordance with § 2.2-4007 of the Code of Virginia that the State Board of Health intends to amend regulations entitled: **12 VAC 5-585. Biosolids Use Regulations.** The purpose of the proposed action is to adopt regulations requiring the payment of fees for the land application of biosolids within local jurisdictions with adopted ordinances providing for such monitoring to ensure compliance with applicable laws and regulations.

Statutory Authority: §§ 32.1-164.5 and 62.1-44.19:3 of the Code of Virginia.

**Contact:** C.M. Sawyer, Division Director, Division of Wastewater Engineering, Department of Health, 1500 E. Main St., Room 109, Richmond, VA 23219, telephone (804) 786-1755 or FAX (804) 786-5567.

## DEPARTMENT OF HEALTH

† **February 6, 2003 - 9 a.m.** -- Open Meeting  
Department of Health, Main Street Station, 1500 East Main Street, 3rd Floor Conference Room, Richmond, Virginia. ☎

A general business and working meeting.

**Contact:** Rene Cabral-Daniels, Director, Office of Health Policy, Department of Health, 1500 E. Main St., Richmond, VA 23219, telephone (804) 786-3561.

## DEPARTMENT OF HEALTH PROFESSIONS

**December 12, 2002 - 9 a.m.** -- Canceled  
**December 13, 2002 - 9 a.m.** -- Open Meeting  
Department of Health Professions, 6606 West Broad Street, 5th Floor, Conference Room 3, Richmond, Virginia. ☎

A bimonthly meeting of the Intervention Program Committee for the Health Practitioners' Intervention Program.

**Contact:** Donna P. Whitney, Intervention Program Manager, Department of Health Professions, 6606 W. Broad St., 4th Floor, Richmond, VA 23230, telephone (804) 662-9424, FAX (804) 662-7358, e-mail donna.whitney@dhp.state.va.us.

## DEPARTMENT OF HISTORIC RESOURCES

### State Review Board and Historic Resources Board

† **December 4, 2002 - 10 a.m.** -- Open Meeting  
Lee School Lofts (formerly Robert E. Lee Elementary School), 3101 Kensington Avenue, Richmond, Virginia. ☎

A quarterly meeting to consider proposed nominations to the Virginia Landmarks Register and the National Register of Historic Places and to consider Register preliminary applications, state highway markers, and historic preservation easements.

**Contact:** Marc Wagner, Register Manager, Department of Historic Resources, 2801 Kensington Ave., Richmond, VA 23221, telephone (804) 367-2323, FAX (804) 367-2391, (804) 367-2386/TTY ☎, e-mail mwagner@dhr.state.va.us.

## BOARD OF HOUSING AND COMMUNITY DEVELOPMENT

**November 18, 2002 - 10 a.m.** -- Open Meeting  
The Jackson Center, 501 North Second Street, 1st Floor, Board Room, Richmond, Virginia. ☎

A regular business meeting.

**Contact:** Steve Calhoun, Senior Policy Analyst, Department of Housing and Community Development, The Jackson Center, 501 N. 2nd St., Richmond, VA 23219-1321, telephone (804) 371-7015, FAX (804) 371-7089, (804) 371-7089/TTY ☎, e-mail scalhoun@dhcd.state.va.us.

## VIRGINIA HOUSING DEVELOPMENT AUTHORITY

**November 19, 2002 - 9 a.m.** -- Open Meeting  
Virginia Housing Development Authority, 601 South Belvidere Street, Richmond, Virginia. ☎

A regular meeting to review and if appropriate approve the minutes from the prior monthly meeting. The board may consider for approval and ratification mortgage loan

---

## Calendar of Events

---

commitments under its multi-family mortgage loan programs; may consider and if appropriate approve amendments to its Rules and Regulations for Allocation of Low-Income Housing Tax Credits; will review the Authority's operations for the prior month; and consider such other matters and take such other actions as they may deem appropriate. Various committees of the Board of Commissioners, including the Programs Committee, the Operations Committee, the Policy Committee, and the Committee of the Whole, may also meet during the day preceding the regular meeting and before and after the regular meeting and may consider matters within their purview. The planned agenda of the meeting will be available at the offices of the authority one week prior to the date of the meeting.

**Contact:** J. Judson McKellar, Jr., General Counsel, Virginia Housing Development Authority, 601 S. Belvidere St., Richmond, VA 23220, telephone (804) 343-5540, FAX (804) 783-6701, toll-free (800) 968-7837, (804) 783-6705/TTY ☎

### VIRGINIA INFORMATION PROVIDERS NETWORK AUTHORITY

† **December 12, 2002 - Noon** -- Open Meeting  
The Library of Virginia, 800 East Broad Street, Conference Room A, Richmond, Virginia. ♿

Agenda will be determined by early December.

**Contact:** Will Prible, Assistant to the Director, Virginia Information Providers Network Authority, 110 S. 7th St., Suite 135, Richmond, VA 23219, telephone (804) 786-4583, FAX (804) 371-2795, e-mail [wprible@vipnetboard.state.va.us](mailto:wprible@vipnetboard.state.va.us).

### JAMESTOWN-YORKTOWN FOUNDATION

**December 12, 2002 - Noon** -- Open Meeting  
The Library of Virginia, 800 East Broad Street, Room A, Richmond, Virginia. ♿ (Interpreter for the deaf provided upon request)

A Jamestown 2007 Steering Committee meeting. Public comment will not be heard.

**Contact:** Laura W. Bailey, Executive Assistant to the Board, Jamestown-Yorktown Foundation, P.O. Box 1607, Williamsburg, VA 23187, telephone (757) 253-4840, FAX (757) 253-5299, toll-free (888) 593-4682, (757) 253-7236/TTY ☎, e-mail [lwbailey@jyf.state.va.us](mailto:lwbailey@jyf.state.va.us).

### STATE BOARD OF JUVENILE JUSTICE

**December 27, 2002** - Public comments may be submitted until this date.

Notice is hereby given in accordance with § 2.2-4007 of the Code of Virginia that the State Board of Juvenile Justice intends to amend regulations entitled: **6 VAC 35-20. Regulations Governing the Certification Process**. The purpose of the proposed action is to govern the process for monitoring compliance with substantive standards by programs in Virginia's juvenile justice system. The process

includes audits and unscheduled visits; administrative review of findings; an appeals process; and the issuance of a variance when a particular standard is inappropriate for a given program. Revisions are sought to simplify the procedural steps in the process.

Statutory Authority: §§ 16.1-233, 16.1-234, 16.1-311, 16.1-312 and 66-10 of the Code of Virginia.

**Contact:** Donald Carignan, Regulatory Coordinator, Department of Juvenile Justice, 700 Centre, 700 E. Franklin St., 4th Floor, Richmond, VA 23219, telephone (804) 371-0743, FAX (804) 371-0773 or e-mail [carigndr@djj.state.va.us](mailto:carigndr@djj.state.va.us).

## DEPARTMENT OF LABOR AND INDUSTRY

### Apprenticeship Council

**December 19, 2002 - 10 a.m.** -- Open Meeting  
Confederate Hills Recreation Building, 302 Lee Avenue, Highland Springs, Virginia. ♿ (Interpreter for the deaf provided upon request)

A quarterly meeting of the council.

**Contact:** Beverley Donati, Assistant Program Director, Department of Labor and Industry, Powers-Taylor Bldg., 13 S. 13th St., Richmond, VA 23219, telephone (804) 786-2382, FAX (804) 786-8418, (804) 786-2376/TTY ☎, e-mail [bgd@doli.state.va.us](mailto:bgd@doli.state.va.us).

### Safety and Health Codes Board

**December 2, 2002 - 10 a.m.** -- Open Meeting  
State Corporation Commission, Tyler Building, 1300 East Main Street, Courtroom B, Second Floor, Richmond, Virginia. ♿ (Interpreter for the deaf provided upon request)

A regular meeting of the board.

**Contact:** Regina P. Cobb, Agency Management Analyst Senior, Department of Labor and Industry, Powers-Taylor Bldg., 13 S. 13th St., Richmond, VA 23219, telephone (804) 786-0610, FAX (804) 786-8418, (804) 786-2376/TTY ☎, e-mail [rlc@doli.state.va.us](mailto:rlc@doli.state.va.us).

### STATE LIBRARY BOARD

**November 18, 2002 - 8:15 a.m.** -- Open Meeting

**January 17, 2003 - 8:15 a.m.** -- Open Meeting  
The Library of Virginia, 800 East Broad Street, Richmond, Virginia. ♿

Meetings of the board to discuss matters pertaining to the Library of Virginia and the board. Committees of the board will meet as follows:

8:15 a.m. - Public Library Development Committee, Orientation Room;  
Publications and Educational Services Committee, Conference Room B;  
Records Management Committee, Conference Room C.

9:30 a.m. - Archival and Information Services Committee, Orientation Room;  
Collection Management Services Committee, Conference Room B;  
Legislative and Finance Committee, Conference Room C.

10:30 a.m. - Library Board, Conference Room 2M.

**Contact:** Jean H. Taylor, Executive Secretary to the Librarian, The Library of Virginia, 800 E. Broad St., Richmond, VA 23219-2000, telephone (804) 692-3535, FAX (804) 692-3594, (804) 692-3976/TTY ☎, e-mail jtaylor@lva.lib.va.us.

## COMMISSION ON LOCAL GOVERNMENT

**November 18, 2002 - 10 a.m.** -- Open Meeting  
Pocahontas Building, 900 East Main Street, Suite 103, Richmond, Virginia. ♿ (Interpreter for the deaf provided upon request)

A regular meeting to consider such matters as may be presented.

**Contact:** Barbara Bingham, Administrative Assistant, Commission on Local Government, 900 E. Main St., Suite 103, Richmond, VA 23219-3513, telephone (804) 786-6508, FAX (804) 371-7999, (800) 828-1120/TTY ☎, e-mail bbingham@clg.state.va.us.

## VIRGINIA MANUFACTURED HOUSING BOARD

**November 21, 2002 - 10 a.m.** -- Open Meeting  
The Jackson Center, 501 North Second Street, Richmond, Virginia. ♿ (Interpreter for the deaf provided upon request)

A regular meeting to review complaints involving manufactured housing licensees, review and process claims to the Manufactured Housing Transaction Recovery Fund, and administer the licensing and recovery fund regulations.

**Contact:** Curtis L. McIver, State Building Code Administrator, Virginia Manufactured Housing Board, State Building Code Administrative Office, 501 N. Second St., Richmond, VA 23219, telephone (804) 371-7160, FAX (804) 371-7092, (804) 371-7089/TTY ☎, e-mail cmciver@dhcd.state.va.us.

## MARINE RESOURCES COMMISSION

NOTE: CHANGE IN MEETING DATE

† **November 26, 2002 - 9:30 a.m.** -- Open Meeting  
† **December 17, 2002 - 9:30 a.m.** -- Open Meeting  
Marine Resources Commission, 2600 Washington Avenue, 4th Floor, Newport News, Virginia. ♿

A monthly commission meeting.

**Contact:** Stephanie Montgomery, Commission Secretary, Marine Resources Commission, 2600 Washington Ave., Suite 107, Newport News, VA 23607, telephone (757) 247-8088, FAX (757) 247-2020, toll-free (800) 541-4646, (757) 247-2292/TTY ☎, e-mail smont@mrc.state.va.us.

## BOARD OF MEDICAL ASSISTANCE SERVICES

**December 10, 2002 - 10 a.m.** -- Open Meeting  
Department of Medical Assistance Services, 600 East Broad Street, Suite 1300, Board Room, Richmond, Virginia. ♿

A routine business meeting. An agenda will be posted.

**Contact:** Nancy Malczewski, Communications Office, Department of Medical Assistance Services, 600 E. Broad St., Suite 1300, Richmond, VA 23219, telephone (804) 786-4626, FAX (804) 371-4981, (800) 343-0634/TTY ☎, e-mail nmalczewski@dmas.state.va.us.

## DEPARTMENT OF MEDICAL ASSISTANCE SERVICES

† **December 9, 2002 - 1 p.m.** -- Open Meeting  
Department of Medical Assistance Services, 600 E. Broad St., Suite 1300, Board Room, Richmond, Virginia. ♿

A routine business of the Pharmacy Liaison Committee.

**Contact:** David Shepherd, R.Ph., Department of Medical Assistance Services, 600 E. Broad St., Suite 1300, Richmond, VA 23219, telephone (804) 225-2772, FAX (804) 225-4393, (800) 343-0634/TTY ☎, e-mail dshepherd@dmas.state.va.us.

## BOARD OF MEDICINE

**November 22, 2002** - Public comments may be submitted until this date.

Notice is hereby given in accordance with § 2.2-4007 of the Code of Virginia that the Board of Medicine intends to amend regulations entitled: **18 VAC 85-20. Regulations Governing the Practice of Medicine, Osteopathy, Podiatry, and Chiropractic.** The purpose of the proposed action is to promulgate regulations governing the practice of medicine related to the administration of anesthesia in physicians' offices in accordance with Chapter 324 of the 2002 Acts of Assembly.

Statutory Authority: §§ 54.1-2400 and 54.1-2912.1 of the Code of Virginia.

Public comments may be submitted until November 22, 2002, to William L. Harp, M.D., Executive Director, Board of Medicine, 6606 West Broad Street, Richmond, VA 23230.

**Contact:** Elaine J. Yeatts, Regulatory Coordinator, Department of Health Professions, 6606 W. Broad St., Richmond, VA 23230, telephone (804) 662-9918, FAX (804) 662-9114 or e-mail elaine.yeatts@dhp.state.va.us.

\*\*\*\*\*

**November 22, 2002** - Public comments may be submitted until this date.

Notice is hereby given in accordance with § 2.2-4007 of the Code of Virginia that the Board of Medicine intends to amend regulations entitled: **18 VAC 85-110. Regulations Governing the Practice of Licensed Acupuncturists.** The purpose of the proposed action is to amend regulations

---

## Calendar of Events

---

in response to a periodic review of regulations to provide consistency in the educational requirements with the national certifying body and to address concerns about the unnecessary burden placed on applicants with a foreign education in acupuncture. Other amendments are recommended to clarify certain provisions of the regulations.

Statutory Authority: §§ 54.1-2400 and 54.1-2956.9 of the Code of Virginia.

Public comments may be submitted until November 22, 2002, to William L. Harp, M.D., Executive Director, Board of Medicine, 6606 West Broad Street, Richmond, VA 23230.

**Contact:** Elaine J. Yeatts, Regulatory Coordinator, Department of Health Professions, 6606 W. Broad St., Richmond, VA 23230, telephone (804) 662-9918, FAX (804) 662-9114 or e-mail elaine.yeatts@dhp.state.va.us.

† **December 4, 2002 - 9:15 a.m.** -- Open Meeting

† **December 5, 2002 - 9:15 a.m.** -- Open Meeting

Department of Health Professions, 6603 West Broad Street, Richmond, Virginia.

A panel of the board will convene a formal hearing into allegations that a practitioner may have violated laws governing the practice of medicine. The panel will meet in open and closed sessions pursuant to the Code of Virginia. Public comment will not be received.

**Contact:** Peggy Sadler/Renee Dixon, Staff, Board of Medicine, 6603 W. Broad St., Richmond, VA, telephone (804) 662-7332, FAX (804) 662-9517, (804) 662-7197/TTY ☎, e-mail peggy.sadler@dhp.state.va.us.

\*\*\*\*\*

**December 6, 2002** - Public comments may be submitted until this date.

Notice is hereby given in accordance with § 2.2-4007 of the Code of Virginia that the Board of Medicine intends to amend regulations entitled: **18 VAC 85-40. Regulations Governing the Practice of Respiratory Care Practitioners.** The purpose of the proposed action is to establish requirements for 20 hours of continuing education per biennium from an approved sponsor or organization, provide for exemptions or extensions of time for compliance, maintenance and provision of documentation upon request, and evidence of continuing education for reinstatement or reactivation of a license. Other amendments are recommended for greater clarity for the regulated entities or for adaptability to computerized testing.

Statutory Authority: §§ 54.1-2400 and 54.1-2912.1 of the Code of Virginia.

Public comments may be submitted until December 6, 2002, to William L. Harp, M.D., Executive Director, Board of Medicine, 6606 West Broad Street, Richmond, VA 23230.

**Contact:** Elaine J. Yeatts, Regulatory Coordinator, Department of Health Professions, 6606 W. Broad St., Richmond, VA 23230, telephone (804) 662-9918, FAX (804) 662-9114 or e-mail elaine.yeatts@dhp.state.va.us.

**December 13, 2002 - 8 a.m.** -- Open Meeting  
Department of Health Professions, 6606 West Broad Street, 5th Floor, Conference Room, Richmond, Virginia. 📍

A meeting of the Executive Committee will be held in open and closed session to review disciplinary files requiring administrative action, adopt amendments and approve for promulgation regulations as presented, interview applicants, and act on other issues that come before the board. The chairman will entertain public comments on agenda items for 15 minutes following adoption of the agenda.

**Contact:** William L. Harp, M.D., Executive Director, Board of Medicine, Southern States Bldg., 6606 W. Broad St., 4th Floor, Richmond, VA 23230-1717, telephone (804) 662-9908, FAX (804) 662-9943, (804) 662-7197/TTY ☎, e-mail wharp@dhp.state.va.us.

**December 13, 2002 - 1 p.m.** -- Open Meeting  
Department of Health Professions, 6606 West Broad Street, 5th Floor, Conference Room, Richmond, Virginia. 📍

A meeting of the Credentials Committee will be held in open and closed session to conduct general business, interview and review medical credentials of applicants applying for licensure in Virginia, and to discuss any other items that may come before the committee. The credentials committee will receive public comments of those persons appearing on behalf of candidates.

**Contact:** William L. Harp, M.D., Executive Director, Board of Medicine, Southern States Bldg., 6606 W. Broad St., 4th Floor, Richmond, VA 23230-1717, telephone (804) 662-9908, FAX (804) 662-9943, (804) 662-7197/TTY ☎, e-mail wharp@dhp.state.va.us.

### Informal Conference Committee

† **November 20, 2002 - 9:30 a.m.** -- Open Meeting

**December 11, 2002 - 9:30 a.m.** -- Open Meeting  
Williamsburg Marriott, 50 Kingsmill Road, Williamsburg, Virginia.

**November 27, 2002 - 9:45 a.m.** -- Open Meeting  
Clarion Hotel, 3315 Ordway Drive, Roanoke, Virginia.

A meeting to inquire into allegations that certain practitioners may have violated laws and regulations governing the practice of medicine and other healing arts in Virginia. The committee will meet in open and closed sessions pursuant to the Code of Virginia. Public comment will not be received.

**Contact:** Peggy Sadler or Renee Dixon, Staff, Department of Health Professions, 6606 W. Broad St., Richmond, VA 23230, telephone (804) 662-7332, FAX (804) 662-9517, (804) 662-7197/TTY ☎, e-mail Peggy.Sadler@dhp.state.va.us.

### STATE MENTAL HEALTH, MENTAL RETARDATION AND SUBSTANCE ABUSE SERVICES BOARD

**December 20, 2002** - Public comments may be submitted until this date.

Notice is hereby given in accordance with § 2.2-4007 of the Code of Virginia that the State Mental Health, Mental Retardation, and Substance Abuse Services Board intends to repeal regulations entitled: **12 VAC 35-40. Mandatory Certification/Licensure Standards for Treatment Programs for Residential Facilities for Children**, and adopt regulations entitled: **12 VAC 35-45. Regulations for Providers of Mental Health, Mental Retardation and Substance Abuse Residential Services for Children**. The purpose of the proposed action is to repeal the existing regulation and promulgate a replacement regulation to eliminate provisions that are duplicative of Standards for Interdepartmental Regulation of Children's Residential Facilities (22 VAC 42-10). The provisions will be updated to reflect current treatment practices in residential treatment facilities for children.

Statutory Authority: §§ 37.1-10, 37.1-179.1 and 37.1-182 of the Code of Virginia.

**Contact:** Leslie Anderson, Director, Office of Licensing, Department of Mental Health, Mental Retardation and Substance Abuse Services, P.O. Box 1797, Richmond, VA 23218-1797, telephone (804) 786-1747, FAX (804) 692-0066 or e-mail dmhmrsas.state.va.us.

\*\*\*\*\*

**January 17, 2003** - Public comments may be submitted until this date.

Notice is hereby given in accordance with § 2.2-4007 of the Code of Virginia that the State Mental Health, Mental Retardation and Substance Abuse Services Board intends to amend regulations entitled: **12 VAC 35-11. Public Participation Guidelines**. The purpose of the proposed action is to update and revise the regulations to be consistent with the current law.

Statutory Authority: §§ 2.2-4007 and 37.1-10 of the Code of Virginia.

**Contact:** Wendy V. Brown, Policy Analyst, Department of Mental Health, Mental Retardation and Substance Abuse Services, P.O. Box 1797, Richmond, VA 23218-1797, telephone (804) 225-2252, FAX (804) 371-0092 or e-mail wbrown@dmhmrsas.state.va.us.

## DEPARTMENT OF MENTAL HEALTH, MENTAL RETARDATION AND SUBSTANCE ABUSE SERVICES

† **November 18, 2002 - 10 a.m.** -- Open Meeting  
Department of Rehabilitative Services, Lee Building, 8004 Franklin Farms Drive, Richmond, Virginia. ♿ (Interpreter for the deaf provided upon request)

The third meeting of the Prevention and Transition Services Issues Team of the Olmstead Task Force.

**Contact:** Fran M. Sadler, Administrative Specialist, Department of Mental Health, Mental Retardation and Substance Abuse Services, P.O. Box 1797, Richmond, VA

23218, telephone (804) 786-8019, FAX (804) 786-9248, (804) 371-8977/TTY ♿, e-mail fsadler@dmhmrsas.state.va.us.

† **December 10, 2002 - 2 p.m.** -- Open Meeting  
Virginia Department for the Deaf and Hard-of-Hearing, Ratcliffe Building, 1602 Rolling Hills Drive, 2nd Floor, Richmond, Virginia. ♿ (Interpreter for the deaf provided upon request)

The Steering Committee of the Olmstead Task Force will hold its third meeting.

**Contact:** Fran M. Sadler, Administrative Specialist, Department of Mental Health, Mental Retardation and Substance Abuse Services, P.O. Box 1797, Richmond, VA 23218, telephone (804) 786-8019, FAX (804) 786-9248, (804) 371-8977/TTY ♿, e-mail fsadler@dmhmrsas.state.va.us.

## STATE MILK COMMISSION

**December 11, 2002 - 10:30 a.m.** -- Open Meeting  
Department of Forestry, 900 Natural Resources Drive, Room 2063, Charlottesville, Virginia. ♿

A regular meeting to consider industry issues, distributor licensing, base transfers, and reports from staff. The commission offers anyone in attendance an opportunity to speak at the conclusion of the agenda. Anyone requiring special accommodations should notify the agency meeting contact at least five working days prior to the meeting date so that suitable arrangements can be made.

**Contact:** Edward C. Wilson, Jr., Deputy Administrator, State Milk Commission, Ninth St. Office Bldg., 202 N. Ninth St., Room 915, Richmond, VA 23219, telephone (804) 786-2013, FAX (804) 786-3779, e-mail ewilson@smc.state.va.us.

## DEPARTMENT OF MINES, MINERALS AND ENERGY

### Virginia Gas and Oil Board

**November 19, 2002 - 9 a.m.** -- Open Meeting  
Southwest Virginia Higher Education Center, Virginia Highlands Community College, Abingdon, Virginia. ♿ (Interpreter for the deaf provided upon request)

A regular meeting to consider petitions filed by applicants for consideration of orders for disbursement from escrow accounts and pooling applications. The public may address the board on individual items as they are called during the hearing. A transcript of the meeting will be taken. Special accommodations for the disabled will be made available at the public meeting on request. Anyone needing special accommodations for the meeting should contact the department by November 12, 2002.

**Contact:** Bob Wilson, Division Director, Department of Mines, Minerals and Energy, P.O. Box 1416, Abingdon, VA 24212, telephone (276) 676-5423, FAX (276) 676-5459, toll-free (800) 828-1120, or email bxw@mme.state.va.us.

---

# Calendar of Events

---

## Governor's Mined Land Reclamation Advisory Committee

**November 21, 2002 - 10 a.m.** -- Open Meeting  
Department of Mines, Minerals and Energy, Buchanan-Smith Building, 3405 Mountain Empire Road, Route 23 South, Big Stone Gap, Virginia.  (Interpreter for the deaf provided upon request)

A meeting to review and discuss recent Interstate Mining Compact Commission (IMCC) issues with the coal industry. Special accommodations for the disabled will be made available on request. Anyone needing special accommodations for the meeting should contact the department at (276) 523-8156 or the Virginia Relay Center 1-800-828-1120/TTY or 1-800-828-1140 by November 10, 2002. Public comments will be received as the last item of the meeting.

**Contact:** Leslie S. Vincent, Customer Services Manager, Department of Mines, Minerals and Energy, P.O. Drawer 900, Big Stone Gap, VA 24219, telephone (276) 523-8156, FAX (276) 523-8163, (800) 828-1120/TTY , e-mail lsv@mme.state.va.us.

## DEPARTMENT OF MOTOR VEHICLES

**December 12, 2002 - 9 a.m.** -- Open Meeting  
Department of Motor Vehicles, 2300 West Broad Street, Room 702, Richmond, Virginia. 

A meeting of the Digital Signature Implementation Workgroup. Meetings will be held on the second Thursday of every other month from 9 a.m. until noon at the location noted above unless otherwise noted. The room will be open for coffee and pre-session business at 8:30 a.m.; the business session will begin at 9 a.m.

**Contact:** Vivian Cheatham, Executive Staff Assistant, Department of Motor Vehicles, 2300 W. Broad St., Richmond, VA 23220, telephone (804) 367-6870, FAX (804) 367-6631 or e-mail dmvmvc@dmv.state.va.us.

## VIRGINIA MUSEUM OF FINE ARTS

**November 20, 2002 - 9 a.m.** -- Open Meeting  
Virginia Museum of Fine Arts, CEO Building Parlor, 2800 Grove Avenue, Richmond, Virginia. 

The following committees will meet:

- 9 a.m. - Museum Expansion Committee
- 11 a.m. - Exhibitions Committee
- 12:30 p.m. - Legislative Committee
- 2 p.m. - Education and Programs Committee
- 3:15 p.m. - Communications and Marketing Committee

**Contact:** Suzanne Broyles, Secretary of the Museum, Virginia Museum of Fine Arts, 2800 Grove Ave., Richmond, VA 23221, telephone (804) 340-1503, FAX (804) 340-1502, (804) 340-1401/TTY , e-mail sbroyles@vmfa.state.va.us.

**November 21, 2002 - 8:30 a.m.** -- Open Meeting  
Virginia Museum of Fine Arts, 2800 Grove Avenue, 2nd Floor Conference Room, Richmond, Virginia. 

The following committees will meet:

- 8:30 a.m. - Buildings and Grounds Committee
- 9:30 a.m. - Collections Committee
- 11 a.m. - Finance Committee

The Board of Trustees will meet at 12:30 p.m.

**Contact:** Suzanne Broyles, Secretary of the Museum, Virginia Museum of Fine Arts, 2800 Grove Ave., Richmond, VA 23221, telephone (804) 340-1503, FAX (804) 340-1502, (804) 340-1401/TTY , e-mail sbroyles@vmfa.state.va.us.

## VIRGINIA MUSEUM OF NATURAL HISTORY

**† November 19, 2002 - 1 p.m.** -- Open Meeting  
LeClair Ryan Consulting, 707 East Main Street, 11th Floor Conference Room, Richmond, Virginia. 

A meeting of the Government Affairs Committee to discuss the museum's legislative issues.

**Contact:** Cindy Rorrer, Administrative Assistant, Virginia Museum of Natural History, 1001 Douglas Ave., Martinsville, VA 24112, telephone (276) 666-8616, FAX (276) 632-6487, (276) 666-8638/TTY , e-mail crorrer@vmnh.org.

**† November 22, 2002 - 9:30 a.m.** -- Open Meeting  
Virginia Museum of Natural History, 1001 Douglas Avenue, Martinsville, Virginia. 

The following committees will meet:

- 9:30 a.m. - Development/Marketing Committee
- 11 a.m. - Nomination Committee
- 1 p.m. - Facilities Committee

**Contact:** Cindy Rorrer, Administrative Assistant, Virginia Museum of Natural History, 1001 Douglas Ave., Martinsville, VA 24112, telephone (276) 666-8616, FAX (276) 632-6487, (276) 666-8638/TTY , e-mail crorrer@vmnh.org.

**December 6, 2002 - 10 a.m.** -- Open Meeting  
LeClair Ryan Consulting, 1010 First Union Building, 213 South Jefferson Street, Roanoke, Virginia. 

A meeting of the Board of Trustees Executive Committee to discuss the management and direction of the museum.

**Contact:** Cindy Rorrer, Director's Assistant, Virginia Museum of Natural History, 1001 Douglas Ave., Martinsville, VA 24112, telephone (276) 666-8616, FAX (276) 632-6487, (276) 666-8638/TTY , e-mail crorrer@vmnh.org.



## BOARD OF NURSING

**November 18, 2002 - 9 a.m.** -- Open Meeting  
**November 20, 2002 - 9 a.m.** -- Open Meeting  
**November 21, 2002 - 9 a.m.** -- Canceled  
**January 27, 2003 - 9 a.m.** -- Open Meeting  
**January 29, 2003 - 9 a.m.** -- Open Meeting  
**January 30, 2003 - 9 a.m.** -- Open Meeting  
Department of Health Professions, 6606 West Broad Street,  
5th Floor, Conference Room 2, Richmond, Virginia. 

A panel of the board will conduct formal hearings with licensees or certificate holders. Public comment will not be received.

**Contact:** Nancy K. Durrett, R.N., Executive Director, Board of Nursing, 6606 W. Broad St., 4th Floor, Richmond, VA 23230, telephone (804) 662-9909, FAX (804) 662-9512, (804) 662-7197/TTY , e-mail nursebd@dhp.state.va.us.

**November 19, 2002 - 9 a.m.** -- Open Meeting  
Department of Health Professions, 6606 West Broad Street,  
5th Floor, Conference Room 2, Richmond, Virginia. 

The board will conduct a general business meeting, including consideration of disciplinary and regulatory actions, and will adopt final regulations for advanced certification of nurse aides. Public comment will be received at 11 a.m.

**Contact:** Nancy K. Durrett, R.N., Executive Director, Board of Nursing, Southern States Bldg., 6606 W. Broad St., 4th Floor, Richmond, VA 23230-1717, telephone (804) 662-9909, FAX (804) 662-9512, (804) 662-7197/TTY , e-mail ndurrett@dhp.state.va.us.

## Special Conference Committee

**December 4, 2002 - 9 a.m.** -- Open Meeting  
**December 9, 2002 - 9 a.m.** -- Open Meeting  
**December 10, 2002 - 9 a.m.** -- Open Meeting  
**December 16, 2002 - 9 a.m.** -- Open Meeting  
**December 18, 2002 - 9 a.m.** -- Open Meeting  
Department of Health Professions, 6606 West Broad Street,  
5th Floor, Richmond, Virginia. 

A Special Conference Committee, comprised of two or three members of the Virginia Board of Nursing, will conduct informal conferences with licensees or certificate holders. Public comment will not be received.

**Contact:** Nancy K. Durrett, R.N., Executive Director, Board of Nursing, 6606 W. Broad St., 4th Floor, Richmond, VA 23230, telephone (804) 662-9909, FAX (804) 662-9512, (804) 662-7197/TTY , e-mail nursebd@dhp.state.va.us.

## BOARD OF NURSING HOME ADMINISTRATORS

**November 21, 2002 - 9 a.m.** -- Open Meeting  
Department of Health Professions, 6606 West Broad Street,  
5th Floor, Conference Room 3, Richmond, Virginia. 

The board will meet to hold a formal hearing. There will not be a public comment period.

**Contact:** Cheri Emma-Leigh, Operations Manager, Board of Nursing Home Administrators, 6606 W. Broad St., 4th Floor, Richmond, VA 23230, telephone (804) 662-9906, FAX (804) 662-7246, (804) 662-7197/TTY , e-mail CEmma-Leigh@dhp.state.va.us.

## BOARDS OF NURSING AND MEDICINE

**November 22, 2002** - Public comments may be submitted until this date.

Notice is hereby given in accordance with § 2.2-4007 of the Code of Virginia that the Boards of Nursing and Medicine intend to amend regulations entitled: **18 VAC 90-30. Regulations Governing the Licensure of Nurse Practitioners.** The purpose of the proposed action is to ensure that certifying agencies providing professional certification necessary for licensure as a nurse practitioner are accredited by an accrediting agency recognized by the U.S. Department of Education or are deemed acceptable to the National Council of State Boards of Nursing. An amendment is also proposed to add a specialty category of nurse practitioner.

Statutory Authority: §§ 54.1-2400 and 54.1-2957 of the Code of Virginia.

Public comments may be submitted until November 22, 2002, to Nancy K. Durrett, R.N., Executive Director, Board of Nursing, 6606 West Broad Street, Richmond, VA 23230.

**Contact:** Elaine J. Yeatts, Regulatory Coordinator, Department of Health Professions, 6606 W. Broad St., Richmond, VA 23230, telephone (804) 662-9918, FAX (804) 662-9114 or e-mail elaine.yeatts@dhp.state.va.us.

## OLD DOMINION UNIVERSITY

**November 18, 2002 - 3 p.m.** -- Open Meeting  
**December 13, 2002 - 1:15 p.m.** -- Open Meeting  
Old Dominion University, Webb University Center, Norfolk,  
Virginia.  (Interpreter for the deaf provided upon request)

A regular meeting of the executive committee of the governing board of the institution to discuss business of the board and the institution as determined by the rector and the president.

**Contact:** Donna Meeks, Executive Secretary to the Board of Visitors, Old Dominion University, 204 Koch Hall, Norfolk, VA 23529, telephone (757) 683-3072, FAX (757) 683-5678, e-mail dmeeks@odu.edu.

## VIRGINIA OUTDOORS FOUNDATION

† **November 19, 2002 - 10:30 a.m.** -- Open Meeting  
Lynchburg Chamber of Commerce, 2015 Memorial Avenue,  
Board Room, Lynchburg, Virginia.

A meeting of the Open Space Lands Preservation Trust Fund Region V Advisory Board to review PTF applications.

**Contact:** Sherry Buttrick, Director, Charlottesville Office, Virginia Outdoors Foundation, 1010 Harris St., Suite 4,

---

## Calendar of Events

---

Charlottesville, VA 22903, telephone (434) 293-3423, FAX (434) 293-3859, e-mail sbuttrick@virginiaoutdoorsfoundation.org.

† **December 5, 2002 - 9:30 a.m.** -- Open Meeting  
Monticello, 1329 Kenwood Farm, State Route 53, Jefferson Library, Charlottesville, Virginia. 

A regularly scheduled meeting of the Board of Trustees to accept conservation easements and to discuss the business of the foundation.

**Contact:** Tamara Vance, Executive Director, Virginia Outdoors Foundation, 203 Governor St., Richmond, VA 23219, telephone (804) 225-2147.

### BOARD OF PHARMACY

**November 22, 2002 - 9 a.m.** -- Open Meeting  
**December 12, 2002 - 9 a.m.** -- Open Meeting  
**December 19, 2002 - 9 a.m.** -- Open Meeting  
Department of Health Professions, 6606 West Broad Street, 5th Floor, Conference Room 3, Richmond, Virginia. 

The Special Conference Committee will discuss disciplinary matter. Public comments will not be received.

**Contact:** Elizabeth Scott Russell, Executive Director, Board of Pharmacy, 6606 W. Broad St., 4th Floor, Richmond, VA 23230, telephone (804) 662-9911, FAX (804) 662-9313.

**December 3, 2002 - 9 a.m.** -- Open Meeting  
Department of Health Professions, 6606 West Broad Street, 5th Floor, Richmond, Virginia. 

A general business meeting, including consideration of regulatory and disciplinary matters as may be presented on the agenda. Public comment will be received during the first 15 minutes of the meeting.

**Contact:** Elizabeth Scott Russell, RPh, Executive Director, Board of Pharmacy, Southern States Bldg., 6606 W. Broad St., 4th Floor, Richmond, VA 23230-1717, telephone (804) 662-9911, FAX (804) 662-9313, (804) 662-7197/TTY , e-mail erussell@dhp.state.va.us.

### POLYGRAPH EXAMINERS ADVISORY BOARD

**December 4, 2002 - 10 a.m.** -- Canceled  
Department of Professional and Occupational Regulation, 3600 West Broad Street, Richmond, Virginia. 

A meeting to conduct board business has been canceled.

**Contact:** Mark N. Courtney, Assistant Director, Department of Professional and Occupational Regulation, 3600 W. Broad St., Richmond, VA 23230, telephone (804) 367-8514, FAX (804) 367-2475, (804) 367-9753/TTY , e-mail polygraph@dpor.state.va.us.

### BOARD FOR PROFESSIONAL AND OCCUPATIONAL REGULATION

**November 18, 2002 - 10 a.m.** -- Open Meeting  
Department of Professional and Occupational Regulation, 3600 West Broad Street, 5th Floor Conference Room,

Richmond, Virginia.  (Interpreter for the deaf provided upon request)

For meeting information contact Judy Spiller.

**Contact:** Judy Spiller, Executive Secretary, Department of Professional and Occupational Regulation, 3600 W. Broad St., Richmond, VA 23230, telephone (804) 367-8519, FAX (804) 367-9537, (804) 367-9753/TTY , e-mail spiller@dpor.state.va.us.

### Professional Boxing and Wrestling Task Force

† **November 21, 2002 - 10 a.m.** -- Open Meeting  
Department of Professional and Occupational Regulation, 3600 West Broad Street, Richmond, Virginia. 

A meeting to review comments received on proposed regulations and make recommendations to the director for adoption of final regulations.

**Contact:** Karen W. O'Neal, Regulatory Programs Coordinator, Department of Professional and Occupational Regulation, 3600 W. Broad St., Richmond, VA 23230, telephone (804) 367-8537, FAX (804) 367-2475, (804) 367-9753/TTY , e-mail oneal@dpor.state.va.us.

### VIRGINIA OFFICE FOR PROTECTION AND ADVOCACY

#### Board for Protection and Advocacy

**November 18, 2002 - 9 a.m.** -- Open Meeting  
Crowne Plaza Hotel, 555 East Canal Street, Richmond, Virginia.  (Interpreter for the deaf provided upon request)

Public comment is welcomed by the board and will be received at 9:15 a.m. Public comment will also be accepted by telephone for persons unable to attend the meeting. Call Claunita Jackson at 1-800-552-3962 (Voice/TTY) to provide public comment via telephone, or e-mail jacksoca@vopa.state.va.us no later than November 11.

**Contact:** Claunita Jackson, Administrative Assistant, Virginia Office for Protection and Advocacy, 202 N. 9th St., 9th Floor, Richmond, VA 23219, telephone (804) 225-3220, FAX (804) 225-3221, toll-free (800) 552-3962, (804) 225-2042/TTY , e-mail jacksoca@vopa.state.va.us.

### BOARD OF PSYCHOLOGY

† **December 10, 2002 - 1 p.m.** -- Open Meeting  
Department of Health Professions, 6603 West Broad Street, 5th Floor, Conference Room 1, Richmond, Virginia. 

The Regulatory Committee will continue discussion regarding a petition for rulemaking on licensure of clinical psychologists. Other regulatory issues may be discussed as presented on the agenda. Public comment will be received at the beginning of the meeting. The full board will meet at 2 p.m. to consider disciplinary and regulatory matters as presented on the agenda. Public comment will be received at the beginning of the meeting.

**Contact:** Evelyn B. Brown, Executive Director, Board of Psychology, Southern States Bldg., 6606 W. Broad St., 4th Floor, Richmond, VA 23230-1717, telephone (804) 662-9913, FAX (804) 662-9943, (804) 662-7197/TTY ☎, e-mail [evelyn.brown@dhp.state.va.us](mailto:evelyn.brown@dhp.state.va.us).

## VIRGINIA RACING COMMISSION

**November 20, 2002 - 9:30 a.m.** -- Open Meeting  
Tyler Building, 1300 East Main Street, Courtroom B, Richmond, Virginia. ♿

A monthly meeting. The commission will consider the request for live Thoroughbred racing days for the year 2003 at the meeting. The licensee is seeking 27 days commencing on June 14, 2003, and concluding on July 22, 2003. Public comment will be received.

**Contact:** William H. Anderson, Director of Policy and Planning, Virginia Racing Commission, 10700 Horsemen's Rd., New Kent, VA 23124, telephone (804) 966-7404, FAX (804) 966-7418, e-mail [Anderson@vrc.state.va.us](mailto:Anderson@vrc.state.va.us).

## REAL ESTATE BOARD

NOTE: PUBLIC COMMENT PERIOD EXTENDED  
**November 20, 2002** - Public comments may be submitted until this date.

Notice is hereby given in accordance with § 2.2-4007 of the Code of Virginia that the Real Estate Board intends to amend regulations entitled: **18 VAC 135-50. Real Estate Board Fair Housing Regulations**. The purpose of the proposed action is to amend existing fair housing regulations to reflect changes in the Code of Virginia and federal law.

Statutory Authority: §§ 36-96.20 and 54.1-2105 of the Code of Virginia.

**Contact:** Karen W. O'Neal, Assistant Director, Department of Professional and Occupational Regulation, 3600 W. Broad St., Richmond, VA 23230, telephone (804) 367-8552, FAX (804) 367-2475, (804) 367-9753/TTY ☎, e-mail [reboard@dpor.state.va.us](mailto:reboard@dpor.state.va.us).

**December 5, 2002 - 9 a.m.** -- Open Meeting  
Department of Professional and Occupational Regulation, 3600 West Broad Street, Richmond, Virginia.

A general business meeting.

**Contact:** Christine Martine, Assistant Director, Real Estate Board, 3600 W. Broad St., Richmond, VA 23230, telephone (804) 367-8552, FAX (804) 367-2475, (804) 367-9753/TTY ☎, e-mail [reboard@dpor.state.va.us](mailto:reboard@dpor.state.va.us).

**December 19, 2002 - 9 a.m.** -- Open Meeting  
**December 20, 2002 - 9 a.m.** -- Open Meeting  
Department of Professional and Occupational Regulation, 3600 West Broad Street, Richmond, Virginia. ♿ (Interpreter for the deaf provided upon request)

A meeting to conduct informal fact finding conferences. Persons desiring to participate in the meeting and requiring special accommodations or interpreter services should

contact the department at least 10 days prior to the meeting so that suitable arrangements can be made. The department fully complies with the Americans with Disabilities Act.

**Contact:** Debbie Amaker, Legal Assistant, Real Estate Board, 3600 W. Broad St., Richmond, VA 23230, telephone (804) 367-8582, FAX (804) 367-0194, (804) 367-9753/TTY ☎, e-mail [amaker@dpor.state.va.us](mailto:amaker@dpor.state.va.us).

## BOARD OF REHABILITATIVE SERVICES

† **January 23, 2003 - 10 a.m.** -- Open Meeting  
Department of Rehabilitative Services, 8004 Franklin Farms Drive, Richmond, Virginia. ♿ (Interpreter for the deaf provided upon request)

A meeting to conduct quarterly business of the board.

**Contact:** Barbara G. Tyson, Administrative Staff Specialist, Department of Rehabilitative Services, 8004 Franklin Farms Dr., Richmond, VA, telephone (804) 662-7010, FAX (804) 662-7644, toll-free (800) 552-5019, (804) 464-9950/TTY ☎, e-mail [tysonbg@drs.state.va.us](mailto:tysonbg@drs.state.va.us).

## DEPARTMENT OF REHABILITATIVE SERVICES

**November 18, 2002 - 4 p.m.** -- Public Hearing  
Woodrow Wilson Rehabilitation Center, William Cashett Chapel, State Route 250, Fishersville, Virginia. ♿ (Interpreter for the deaf provided upon request)

The Virginia Department of Rehabilitative Services will hold public forums to seek input regarding vocational rehabilitation and supported employment services provided to Virginians with disabilities. The state plan is available for review at [www.vadrs.org](http://www.vadrs.org), the Department of Rehabilitative Services sponsored website, or at [www.va-src.org](http://www.va-src.org), the website sponsored by the State Rehabilitation Council.

**Contact:** Elizabeth Smith, Policy and Planning Director, Department of Rehabilitative Services, 8004 Franklin Farms Dr., P.O. Box K-300, Richmond, VA 23288-0300, telephone (804) 662-7071, FAX (804) 662-7696, toll-free (800) 552-5019, (800) 464-9950/TTY ☎, e-mail [smithee@drs.state.va.us](mailto:smithee@drs.state.va.us).

## VIRGINIA RESOURCES AUTHORITY

**December 10, 2002 - 9 a.m.** -- Open Meeting  
Virginia Resources Authority, 707 East Main Street, 2nd Floor Conference Room, Richmond, Virginia. ♿

A regular meeting of the Board of Directors to (i) review and, if appropriate, approve the minutes from the most recent monthly meeting; (ii) review the authority's operations for the prior month; (iii) review applications for loans submitted to the authority for approval; (iv) consider loan commitments for approval and ratification under its various programs; (v) approve the issuance of any bonds; (vi) review the results of any bond sales; and (vii) consider such other matters and take such other actions as it may deem appropriate. Various committees of the Board of

---

# Calendar of Events

---

Directors may also meet immediately before or after the regular meeting and consider matters within their purview. The planned agenda of the meeting and any committee meetings will be available at the offices of the authority one week prior to the date of the meeting. Any person who needs any accommodation in order to participate in the meeting should contact the authority at least 10 days before the meeting so that suitable arrangements can be made.

**Contact:** Bonnie R. C. McRae, Executive Assistant, Virginia Resources Authority, 707 E. Main St., Richmond, VA 23219, telephone (804) 644-3100, FAX (804) 644-3109, e-mail [bmcr@vra.state.va.us](mailto:bmcr@vra.state.va.us).

## STATE BOARD OF SOCIAL SERVICES

**November 22, 2002** - Public comments may be submitted until this date.

Notice is hereby given in accordance with § 2.2-4007 of the Code of Virginia that the State Board of Social Services intends to adopt regulations entitled: **22 VAC 40-375. Economic and Employment Improvement Program for Disadvantaged Persons.** The purpose of the proposed action is to establish a regulation that implements the Economic and Employment Improvement Program for Disadvantaged Persons.

Statutory Authority: §§ 63.2-217 and 63.2-700 et seq. of the Code of Virginia.

**Contact:** Faye Palmer, Manager, Job Readiness and Employment, Department of Social Services, 730 E. Broad St., Richmond, VA 23219, telephone (804) 692-1065, FAX (804) 225-2202 or e-mail [afp900@email1.dss.state.va.us](mailto:afp900@email1.dss.state.va.us).

\* \* \* \* \*

**November 22, 2002** - Public comments may be submitted until this date.

Notice is hereby given in accordance with § 2.2-4007 of the Code of Virginia that the State Board of Social Services intends to amend regulations entitled: **22 VAC 40-700. Child Protective Services Central Registry Information.** The purpose of the proposed action is to ensure that the regulation is consistent with the regulation entitled Child Protective Services, 22 VAC 40-705, which requires preponderance of the evidence for founded disposition; and to ensure consistency with the Virginia Court of Appeals decision of Jackson v. Marshall, which determined that only categories of "founded" and "unfounded" are allowed under § 63.1-248 of the Code of Virginia. The department officially ceased use of the Reason to Suspect category on March 9, 1995.

Statutory Authority: §§ 63.2-217 and 63.2-1515 of the Code of Virginia.

**Contact:** Jesslyn Cobb, Program Specialist, Department of Social Services, 730 E. Broad St., Richmond, VA 23219-1849, telephone (804) 692-1255, FAX (804) 692-2215 or e-mail [jqc900@email1.dss.state.va.us](mailto:jqc900@email1.dss.state.va.us).

**December 18, 2002 - 9 a.m.** -- Open Meeting  
**December 19, 2002 - 9 a.m.** -- Open Meeting  
Ramada Inn 1776, 725 Bypass Road, Williamsburg, Virginia. 

A formal business meeting of the board.

**Contact:** Pat Rengnerth, Board Liaison, State Board of Social Services, 730 E. Broad St., Suite 812, Richmond, VA 23219-1849, telephone (804) 692-1826, FAX (804) 692-1962, (800) 828-1120/TTY , e-mail [pvr2@email1.dss.state.va.us](mailto:pvr2@email1.dss.state.va.us).

## DEPARTMENT OF SOCIAL SERVICES

**December 6, 2002 - 10 a.m.** -- Open Meeting  
Department of Social Services, 730 East Broad Street, 8th Floor, Conference Room, Richmond, Virginia. 

A regular business meeting of the Family and Children's Trust Fund Board of Trustees.

**Contact:** Nan McKenney, Executive Director, State Board of Social Services, 730 E. Broad St., Richmond, VA 23219-1849, telephone (804) 692-1823, FAX (804) 692-1869.

## BOARD OF SOCIAL WORK

† **December 13, 2002 - 10 a.m.** -- Open Meeting  
Department of Health Professions, 6603 West Board Street, 5th Floor, Conference Room 4, Richmond, Virginia. 

The Special Conference Committee will convene for an informal conference to hear possible violations of the laws and regulations governing the practice of social work. No public comment will be heard.

**Contact:** Rai Minor, Administrative Assistant, Board of Social Work, 6603 W. Broad St., 5th Floor, Richmond, VA 23230-1712, telephone (804) 662-9914, FAX (804) 662-7250, (804) 662-7197/TTY , e-mail [bsw@dhp.state.va.us](mailto:bsw@dhp.state.va.us).

## DEPARTMENT OF TAXATION

### Governor's Advisory Council on Revenue Estimates

**November 25, 2002 - 3 p.m.** -- Open Meeting  
The Library of Virginia, 800 East Broad Street, Richmond, Virginia. 

The annual meeting of the council.

**Contact:** Carolyn Johnson, Agency Management Analyst, Department of Taxation, 2220 W. Broad St., Richmond, VA, telephone (804) 367-8391, FAX (804) 367-6020, e-mail [cjohnson@tax.state.va.us](mailto:cjohnson@tax.state.va.us).

## DEPARTMENT OF TECHNOLOGY PLANNING

### Virginia Research and Technology Advisory Commission

**December 12, 2002 - 1:30 p.m.** -- Open Meeting  
Jefferson Labs, 12000 Jefferson Avenue, Newport News, Virginia.

A quarterly meeting to coincide with the Virginia Biotechnology Summit.

**Contact:** K. C. Das, Department of Technology Planning, 110 S. 7th Street, Suite 135, Richmond, VA 23219, telephone (804) 371-5599, FAX (804) 371-2795, e-mail kcdas@dit.state.va.us.

### Virginia Geographic Information Network Advisory Board

**January 2, 2003 - 1:30 p.m.** -- Open Meeting  
Richmond Plaza Building, 110 South 7th Street, 3rd Floor Training Room, Richmond, Virginia. 

A regular meeting.

**Contact:** Bill Shinar, VGIN Coordinator, Department of Technology Planning, 110 S. 7th St., Suite 135, Richmond, VA 23219, telephone (804) 786-8175, FAX (804) 371-2795, e-mail bshinar@vgin.state.va.us.

## VIRGINIA TOBACCO SETTLEMENT FOUNDATION

**December 3, 2002 - 1:30 p.m.** -- Open Meeting  
The Hilton Garden Inn, Richmond Innsbrook, 4050 Cox Road, Glen Allen, Virginia. 

A meeting of the Board of Trustees to discuss the initial evaluation results of our marketing campaign.

**Contact:** Eloise Burke, Administrative Specialist, Virginia Tobacco Settlement Foundation, 701 E. Franklin St., Suite 501, Richmond, VA 23219, telephone (804) 786-2523, FAX (804) 225-2272, e-mail eburke@tsf.state.va.us.

## COMMONWEALTH TRANSPORTATION BOARD

**November 20, 2002 - 2 p.m.** -- Open Meeting  
† **December 18, 2002 - 2 p.m.** -- Open Meeting  
Department of Transportation, 1221 East Broad Street, Auditorium, Richmond, Virginia. 

A work session of the Commonwealth Transportation Board and the Department of Transportation staff.

**Contact:** Sandra M. Mills, Assistant Legislative Liaison, Department of Transportation, 1401 E. Broad St., Richmond, VA 23219, telephone (804) 225-4701, FAX (804) 225-4700, e-mail Sandee.Mills@VirginiaDOT.org.

**November 21, 2002 - 9 a.m.** -- Open Meeting  
† **December 19, 2002 - 10 a.m.** -- Open Meeting  
Department of Transportation, 1221 East Broad Street, Auditorium, Richmond, Virginia. 

A monthly meeting to vote on proposals presented regarding bids, permits, additions and deletions to the highway system, and any other matters requiring board approval. Public comment will be received at the outset of the meeting on items on the meeting agenda for which the opportunity for public comment has not been afforded the public in another forum. Remarks will be limited to five minutes. Large groups are asked to select one individual to speak for the group. The board reserves the right to amend these conditions. Separate committee meetings may be held on call of the chairman. Contact VDOT Public Affairs at (804) 786-2715 for schedule.

**Contact:** Sandra M. Mills, Assistant Legislative Liaison, Department of Transportation, 1401 E. Broad St., Richmond, VA 23219, telephone (804) 225-4701, FAX (804) 225-4700, e-mail Sandee.Mills@VirginiaDOT.org.

\* \* \* \* \*

† **December 16, 2002 - 7 p.m.** -- Public Hearing  
Department of Transportation, 1221 East Broad Street, 1st Floor, Auditorium, Richmond, Virginia.

**January 17, 2003** - Public comments may be submitted until this date.

Notice is hereby given in accordance with § 2.2-4007 of the Code of Virginia that the Commonwealth Transportation Board intends to amend regulations entitled: **24 VAC 30-71. Minimum Standards of Entrances to State Highways.** The purpose of the proposed action is to update regulatory content and documents referenced, and incorporate suggested changes pursuant to the most recent periodic review.

Statutory Authority: §§ 33.1-12, 33.1-197 and 33.1-198 of the Code of Virginia.

**Contact:** Steve D. Edwards, Transportation Engineer Senior, Mobility Engineer Senior, Department of Transportation, 1100 Bank St., Richmond, VA 23219, telephone (804) 786-0121, FAX (804) 225-2448 or e-mail Steve.Edwards@VirginiaDOT.org.

## DEPARTMENT OF THE TREASURY

**November 20, 2002 - 9 a.m.** -- Open Meeting  
James Monroe Building, 101 North 14th Street, 3rd Floor, Richmond, Virginia. 

A meeting of the board.

**Contact:** Gloria Hatchel, Department of the Treasury, James Monroe Bldg., 101 N. 14th St., 3rd Floor, Richmond VA 23219, telephone (804) 371-6011, e-mail gloria.hatchel@trs.state.va.us.

## VIRGINIA WAR MEMORIAL FOUNDATION

**January 7, 2003 - Noon** -- Open Meeting  
Virginia War Memorial, 621 South Belvidere Street, Richmond, Virginia.  (Interpreter for the deaf provided upon request)

---

# Calendar of Events

---

A regular meeting of the Board of Trustees. Public comments will be heard.

**Contact:** Sandra H. Williams, Associate Director, Virginia War Memorial Foundation, 621 S. Belvidere St., Richmond, VA 23220, telephone (804) 786-2060, FAX (804) 786-6652, (804) 786-6152/TTY ☎, e-mail swilliams@vawarmemorial.state.va.us.

## VIRGINIA WASTE MANAGEMENT BOARD

**December 6, 2002** -- Public comments may be submitted until this date.

Notice is hereby given in accordance with § 2.2-4007 of the Code of Virginia that the Virginia Waste Management Board intends to amend regulations entitled: **9 VAC 20-80. Solid Waste Management Regulations.** The purpose of the proposed action is to address the remaining statutory changes passed during recent General Assembly sessions that are not addressed in Amendment 2.

Statutory Authority: § 10.1-1402 of the Code of Virginia.

**Contact:** Michael J. Dieter, Department of Environmental Quality, P.O. Box 10009, Richmond, VA 23240, telephone (804) 698-4238, e-mail mjdieter@deq.state.va.us.

## STATE WATER CONTROL BOARD

**November 21, 2002 - 7 p.m.** -- Public Hearing  
King George High School Auditorium, 8246 Dahlgren Road, King George, Virginia. ♿

A public hearing on the proposed reissuance, plant expansion and outfall relocation for the King George County Service Authority's Dahlgren wastewater treatment plant. The public comment period closes on December 6, 2002.

**Contact:** James A. Olson, State Water Control Board, 13901 Crown Ct., Woodbridge, VA 22193, telephone (703) 583-3836, e-mail jaolson@deq.state.va.us.

† **December 11, 2002 - 9:30 a.m.** -- Open Meeting  
General Assembly Building, 9th and Broad Streets, House Room D, Richmond, Virginia. ♿

A regular meeting.

**Contact:** Cindy Berndt, Regulatory Coordinator, Department of Environmental Quality, P.O. Box 10009, Richmond, VA 23240, telephone (804) 698-4378, FAX (804) 698-4346, e-mail cmberndt@deq.state.va.us.

## VIRGINIA BOARD FOR WATERWORKS AND WASTEWATER WORKS OPERATORS

**December 12, 2002 - 8:30 a.m.** -- Open Meeting  
Department of Professional and Occupational Regulation, 3600 West Broad Street, Conference Room 5W, Richmond, Virginia. ♿

The board will conduct routine business. A public comment period will be held at the beginning of the meeting.

**Contact:** David Dick, Assistant Director, Department of Professional and Occupational Regulation, 3600 W. Broad St., Richmond, VA 23230, telephone (804) 367-2648, FAX (804) 367-6128, (804) 367-9753/TTY ☎, e-mail waterwasteoper@dpor.state.va.us.

## THE COLLEGE OF WILLIAM AND MARY

**November 21, 2002 - 10 a.m.** -- Open Meeting  
Richard Bland College, 11301 Johnson Road, Student Center, Executive Board Room, Petersburg, Virginia. ♿ (Interpreter for the deaf provided upon request)

The Board of Visitors will tour the campus of Richard Bland College, receive reports from the administration, faculty and students of Richard Bland and act on those resolutions presented by the administration. The meeting is open to the public, but there will be no opportunity for public comment.

**Contact:** William T. Walker, Jr., Associate Vice President for Public Affairs, The College of William and Mary, 312 Jamestown Rd., Williamsburg, VA 23185-4042, telephone (757) 221-2624, FAX (757) 221-1021, e-mail wtwal2@wm.edu.

**November 21, 2002 - 2 p.m.** -- Open Meeting  
The College of William and Mary, Blow Memorial Hall, 262 Richmond Road, Board Room, Williamsburg, Virginia. ♿ (Interpreter for the deaf provided upon request)

Committees of the Board will receive reports from the administration, faculty and students of the College of William and Mary. The meetings are open to the public, but there will be no opportunity for public comment.

**Contact:** William T. Walker, Jr., Associate Vice President for Public Affairs, The College of William and Mary, 312 Jamestown Rd., Williamsburg, VA 23185-4042, telephone (757) 221-2624, FAX (757) 221-1021, e-mail wtwal2@wm.edu.

**November 22, 2002 - 8 a.m.** -- Open Meeting  
The College of William and Mary, Blow Memorial Hall, 262 Richmond Road, Board Room, Williamsburg, Virginia. ♿ (Interpreter for the deaf provided upon request)

The board will meet in committee from 8 a.m. to 11:45 a.m. to receive reports from the administration of William and Mary. The full board will meet from 11:45 a.m. to 1 p.m. to receive reports from the committees of the board, the administrations of Richard Bland College and the College of William and Mary, and to act on those resolutions presented by the administrations of both institutions. The meetings are open to the public, but there will be no opportunity for public comment.

**Contact:** William T. Walker, Jr., Associate Vice President for Public Affairs, The College of William and Mary, 312 Jamestown Rd., Williamsburg, VA 23185-4042, telephone (757) 221-2624, FAX (757) 221-1021, e-mail wtwal2@wm.edu.

## VIRGINIA WORKFORCE COUNCIL

† **December 5, 2002 - 10 a.m.** -- Open Meeting  
Holiday Inn SunSpree Resort, 3900 Atlantic Avenue, Virginia Beach, Virginia.  (Interpreter for the deaf provided upon request)

Agenda items include: Incentive Award presentations; performance reports for WIA and VCCS regional workforce centers; existing workforce strategy policy; rapid response statewide 25% grants.

**Contact:** Gail Robinson, Virginia Workforce Council Liaison, Virginia Employment Commission, P.O. Box 1358, Richmond, VA 23218-1358, telephone (804) 225-3070, FAX (804) 225-2190, (800) 828-1120/TTY , e-mail grobinson@vec.state.va.us.

## INDEPENDENT

### VIRGINIA RETIREMENT SYSTEM

**November 19, 2002 - Noon** -- Open Meeting  
**December 18, 2002 - Noon** -- Open Meeting  
VRS Headquarters, 1200 East Main Street, Richmond, Virginia. 

A regular meeting of the Optional Retirement Plan Advisory Committee.

**Contact:** Darla K. Glazier, Office Manager, Virginia Retirement System, 1200 E. Main St., Richmond, VA 23219, telephone (804) 649-8059, FAX (804) 786-1541, toll-free (888) 827-3847, (804) 344-3190/TTY , e-mail dglazier@vrs.state.va.us.

**November 20, 2002 - 11 a.m.** -- Open Meeting  
VRS Headquarters, 1200 East Main Street, Richmond, Virginia. 

Committees will meet as follows:  
11 a.m. - Investment Advisory Committee  
11:30 a.m. - Audit and Compliance Committee - Note change in meeting time  
3 p.m. - Benefits and Actuarial Committee - Note change in meeting time  
2:30 p.m. - Administrative and Personnel Committee - Canceled

**Contact:** Darla K. Glazier, Office Manager, Virginia Retirement System, 1200 E. Main St., Richmond, VA 23219, telephone (804) 649-8059, FAX (804) 786-1541, toll-free (888) 827-3847, (804) 344-3190/TTY , e-mail dglazier@vrs.state.va.us.

**November 21, 2002 - 9 a.m.** -- Open Meeting  
**December 19, 2002 - 9 a.m.** -- Open Meeting  
VRS Headquarters, 1200 East Main Street, Richmond, Virginia. 

A regular meeting of the Board of Trustees. No public comment will be received.

**Contact:** Darla K. Glazier, Office Manager, Virginia Retirement System, P.O. Box 2500, Richmond, VA 23218, telephone (804) 649-8059, FAX (804) 786-1541, toll-free (888) 827-3847, (804) 344-3190/TTY , e-mail dkestner@vrs.state.va.us.

**November 21, 2002 - 12:15 p.m.** -- Open Meeting  
**December 19, 2002 - 12:15 p.m.** -- Open Meeting  
**January 23, 2003 - 12:15 p.m.** -- Open Meeting  
VRS Investment Department, Bank of America Building, 1111 East Main Street, 4th Floor, Richmond, Virginia. 

A regular meeting of the Corporate Governance Task Force.

**Contact:** Phyllis Henderson, Investment Department Administrative Assistant, Virginia Retirement System, 1111 E. Main St., Richmond, VA 23219, telephone (804) 697-6675, FAX (804) 786-1541, toll-free (888) 827-3847, e-mail phenderson@vrs.state.va.us.

**December 18, 2002 - 3 p.m.** -- Open Meeting  
Bank of America Building, 1111 East Main Street, 4th Floor Conference Room, Richmond, Virginia. 

A regular meeting of the Investment Advisory Committee. No public comment will be received at the meeting.

**Contact:** Phyllis Henderson, Virginia Retirement System, 1111 E. Main St., Richmond, Virginia 23219, telephone (804) 649-8059, FAX (804) 786-1541, toll-free (888) 827-3847, (804) 344-3190/TTY , e-mail phenderson@vrs.state.va.us.

## LEGISLATIVE

### VIRGINIA CODE COMMISSION

**December 3, 2002 - 10 a.m.** -- Open Meeting  
General Assembly Building, 910 Capitol Street, 6th Floor, Speaker's Conference Room, Richmond, Virginia.  (Interpreter for the deaf provided upon request)

A meeting to continue with the recodification of Title 25, Eminent Domain. Public comments will be received at the end of the meeting.

**Contact:** Jane D. Chaffin, Registrar of Regulations, Virginia Code Commission, 910 Capitol St., Richmond, VA 23219, telephone (804) 786-3591, FAX (804) 692-0625, e-mail jchaffin@leg.state.va.us.

### STUDY ON THE STATE AND LOCAL GOVERNMENT CONFLICT OF INTERESTS ACT

† **November 20, 2002 - 10 a.m.** -- Open Meeting  
State Capitol, House Room 2, Richmond, Virginia. 

A regular meeting. Questions about the agenda should be addressed to Amigo Wade, Division of Legislative Services, (804) 786-3591.

**Contact:** Lois V. Johnson, House Committee Operations, P.O. Box 406, Richmond, VA 23218, telephone (804) 698-1540 or (804) 786-2369/TTY 

---

# Calendar of Events

---

## DR. MARTIN LUTHER KING JR. MEMORIAL COMMISSION

**December 17, 2002 - 10 a.m.** -- Open Meeting  
General Assembly Building, 9th and Broad Streets, Senate Room A, Richmond, Virginia. 

A regular meeting. Questions about the agenda should be addressed to Brenda Edwards or Norma Szakal, Division of Legislative Services, (804) 786-3591.

**Contact:** Anne R. Howard, House Committee Operations, P.O. Box 406, Richmond, VA 23218, telephone (804) 698-1540 or (804) 786-2369/TTY 

## VIRGINIA FREEDOM OF INFORMATION ADVISORY COUNCIL

**November 18, 2002 - 2 p.m.** -- Open Meeting  
General Assembly Building, 9th and Broad Streets, House Room D, Richmond, Virginia.  (Interpreter for the deaf provided upon request)

A regular meeting.

**Contact:** Maria J.K. Everett, Executive Director, Virginia Freedom of Information Advisory Council, General Assembly Bldg., 910 Capitol St., 2nd Floor, Richmond, VA 23219, telephone (804) 225-3056, FAX (804) 371-0169, toll-free (866) 448-4100, e-mail foiaacouncil@leg.state.va.us.

## JOINT COMMISSION ON PRESCRIPTION DRUG ASSISTANCE

† **November 20, 2002 - 10 a.m.** -- Open Meeting  
State Capitol, House Room 4, Richmond, Virginia. 

A regular meeting. Questions about the agenda should be addressed to Gayle Vergara, Division of Legislative Services, (804) 786-3591.

**Contact:** Lois V. Johnson, House Committee Operations, P.O. Box 406, Richmond, VA 23218, telephone (804) 698-1540 or (804) 786-2369/TTY 

## JOINT COMMISSION ON TECHNOLOGY AND SCIENCE

† **November 20, 2002 - 1 p.m.** -- Open Meeting  
General Assembly Building, 9th and Broad Streets, 4th Floor West Conference Room, Richmond, Virginia. 

A meeting of the Integrated Government Advisory Committee.

**Contact:** Eric Link, Staff Attorney, Joint Commission on Technology and Science, General Assembly Bldg., 910 Capitol St., 2nd Floor, Richmond, VA 23219, telephone (804) 786-3591, e-mail elink@leg.state.va.us.

**December 10, 2002 - 10 a.m.** -- Open Meeting  
General Assembly Building, 9th and Broad Streets, 9th Floor, House Appropriations Committee Room, Richmond, Virginia. 

A meeting to receive updates on biotechnology and nanotechnology and to adopt a legislative agenda for the 2003 Session.

**Contact:** Mitchell Goldstein, Director, Joint Commission on Technology and Science, 910 Capitol St., 2nd Floor, Richmond, VA 23219, telephone (804) 786-3591, e-mail jcots@leg.state.va.us.

## CHRONOLOGICAL LIST

### OPEN MEETINGS

#### November 18

Education, Board of  
- Advisory Board for Teacher Education and Licensure  
Freedom of Information Advisory Council, Virginia  
Housing and Community Development, Board of  
Library Board, State  
- Archival and Information Systems  
- Collection Management Services Committee  
- Legislative and Finance Committee  
- Publications and Educational Services Committee  
- Public Library Development Committee  
- Records Management Committee  
Local Government, Commission on  
† Mental Health, Mental Retardation and Substance Abuse Services, Department of  
Nursing, Board of  
Old Dominion University  
- Executive Committee  
Professional and Occupational Regulation, Board for  
Protection and Advocacy, Virginia Office for

#### November 19

† Agriculture and Consumer Services, Department of  
- Farmland Preservation Task Force  
† Child Day-Care Council  
Environmental Quality, Department of  
- Ground Water Protection Steering Committee  
† Funeral Directors and Embalmers, Board of  
- Legislative/Regulatory Committee  
Housing Development Authority, Virginia  
Marine Resources Commission  
Mines, Mineral and Energy, Department of  
- Gas and Oil Board  
† Natural History, Virginia Museum of  
- Government Affairs Committee  
Nursing, Board of  
† Outdoors Foundation, Virginia  
- Open Space Lands Preservation Trust Fund Region V  
Advisory Board  
Retirement System, Virginia  
- Optional Retirement Plan Advisory Committee

#### November 20

Community Colleges, State Board for  
- Academic and Student Affairs Committee  
- Audit Committee  
- Budget and Finance Committee  
† Conflicts of Interest Act, Study on the State and Local  
Government  
Education, Board of



Environmental Quality, Department of  
 † Funeral Directors and Embalmers, Board of  
 † Medicine, Board of  
 - Informal Conference Committee  
 Museum of Fine Arts, Virginia  
 - Communications and Marketing Committee  
 - Education and Programs Committee  
 - Exhibitions Committee  
 - Museum Expansion Committee  
 - Legislative Committee  
 Nursing, Board of  
 † Prescription Drug Assistance, Joint Commission on  
 Racing Commission, Virginia  
 Retirement System, Virginia  
 - Administration and Personnel Committee  
 - Audit and Compliance Committee  
 - Benefits and Actuarial Committee  
 - Investment Advisory Committee  
 † Technology and Science, Joint Commission on  
 Transportation Board, Commonwealth  
 Treasury Board

## November 21

Community Colleges, State Board for  
 † Counseling, Board of  
 - Credentials Committee  
 - Regulatory Committee  
 Design-Build/Construction Management Review Board  
 George Mason University  
 - Board of Visitors  
 Manufactured Housing Board, Virginia  
 Mines, Mineral and Energy, Department of  
 - Governor's Mined Land Reclamation Advisory  
 Committee  
 Museum of Fine Arts, Virginia  
 - Board of Trustees  
 - Buildings and Grounds Committee  
 - Collections Committee  
 - Finance Committee  
 Nursing Home Administrators, Board of  
 † Professional and Occupational Regulation, Board for  
 Retirement System, Virginia  
 - Board of Trustees  
 - Corporate Governance Task Force  
 Transportation Board, Commonwealth  
 William and Mary, The College of  
 - Board of Visitors

## November 22

Accountancy, Board of  
 † Counseling, Board of  
 Dentistry, Board of  
 - Special Conference Committee  
 † Museum of Natural History, Virginia  
 - Development/Marketing Committee  
 - Facilities Committee  
 - Nomination Committee  
 Pharmacy, Board of  
 - Special Conference Committee  
 William and Mary, The College of  
 - Board of Visitors

## November 23

† Conservation and Recreation, Department of  
 - Virginia Cave Board

## November 25

Alcoholic Beverage Control Board  
 Conservation and Recreation, Department of  
 - Chippokes Plantation Farm Foundation Board of  
 Trustees  
 Taxation, Department of  
 - Governor's Advisory Council on Revenue Estimates

## November 26

Compensation Board  
 † Fire Services Board, Virginia  
 † Governor's Commission on Efficiency and Effectiveness  
 † Marine Resources Commission

## November 27

Medicine, Board of  
 - Informal Conference Committee

## December 2

Labor and Industry, Department of  
 - Safety and Health Codes Board

## December 3

Code Commission, Virginia  
 † Economic Development Partnership, Virginia  
 Funeral Directors and Embalmers, Board of  
 † Pharmacy, Board of  
 Tobacco Settlement Foundation, Virginia  
 - Board of Trustees

## December 4

Contractors, Board for  
 † Dentistry, Board of  
 Education, Board of  
 - Committee to Implement NCLB  
 † Emergency Planning Committee, Local - Winchester  
 Gaming Commission, Charitable  
 † Historic Resources, Department of  
 - State Review Board and Historic Resources Board  
 † Medicine, Board of  
 Nursing, Board of  
 - Special Conference Committee

## December 5

Conservation and Recreation, Department of  
 - Falls of the James Scenic River Advisory Board  
 † Fire Services Board, Virginia  
 - Administration and Policy Committee  
 - Finance Committee  
 - Fire Education and Training Committee  
 - Fire Prevention and Control Committee  
 † Medicine, Board of  
 † Outdoors Foundation, Virginia  
 - Board of Trustees  
 Real Estate Board  
 † Workforce Council, Virginia

## December 6

Art and Architectural Review Board  
 † Counseling, Board of  
 - Special Conference Committee  
 † Dentistry, Board of  
 † Fire Services Board, Virginia  
 † Health, Department of  
 Museum of Natural History, Virginia  
 - Board of Trustees Executive Committee  
 Social Services, State Board of  
 - Family and Children's Trust Fund Board

---

# Calendar of Events

---

**December 7**

Blind and Vision Impaired, Department for the  
- Statewide Rehabilitation Council for the Blind

**December 9**

Alcoholic Beverage Control Board  
† Chesapeake Bay Local Assistance Board  
† Medical Assistance Services, Department of  
- Pharmacy Liaison Committee  
Nursing, Board of  
Special Conference Committee

**December 10**

Medical Assistance Services, Board of  
† Mental Health, Mental Retardation and Substance Abuse  
Services, Department of  
Nursing, Board of  
- Special Conference Committee  
† Psychology, Board of  
- Regulatory Committee  
Resources Authority, Virginia  
Technology and Science, Joint Commission on

**December 11**

Architects, Professional Engineers, Land Surveyors,  
Certified Interior Designers and Landscape Architects,  
Board for  
† Conservation and Recreation, Department of  
- Virginia Soil and Water Conservation Board  
Medicine, Board of  
- Informal Conference Committee  
Milk Commission, State  
† Water Control Board, State

**December 12**

† Information Providers Network Authority, Virginia  
Jamestown-Yorktown Foundation  
- Jamestown 2007 Steering Committee  
Motor Vehicles, Department of  
- Digital Signature Implementation Workgroup  
Pharmacy, Board of  
- Special Conference Committee  
Technology Planning, Department of  
- Virginia Research and Technology Advisory  
Commission  
Waterworks and Wastewater Works Operators, Virginia  
Board for

**December 13**

Health Professions, Department of  
- Intervention Program Committee  
Medicine, Board of  
- Credentials Committee  
- Executive Committee  
Old Dominion University  
- Executive Committee  
† Social Work, Board of  
- Special Conference Committee

**December 16**

Nursing, Board of  
- Special Conference Committee

**December 17**

Dr. Martin Luther King, Jr. Memorial Commission  
† Marine Resources Commission

**December 18**

Nursing, Board of  
- Special Conference Committee

Retirement System, Virginia  
- Investment Advisory Committee  
- Optional Retirement Plan Advisory Committee  
Social Services, State Board of  
† Transportation Board, Commonwealth

**December 19**

Design-Build/Construction Management Review Board  
Labor and Industry, Department of  
- Virginia Apprenticeship Council  
Pharmacy, Board of  
- Special Conference Committee  
Real Estate Board  
Retirement System, Virginia  
- Board of Trustees  
- Corporate Governance Task Force  
Social Services, State Board of  
† Transportation Board, Commonwealth

**December 20**

Real Estate Board

**December 23**

Alcoholic Beverage Control Board

**January 2, 2003**

Technology Planning, Department of  
- Virginia Geographical Information Network Advisory  
Board

**January 6**

† Education, Board of

**January 7**

War Memorial Foundation, Virginia

**January 9**

Education, Board of  
- State Special Education Advisory Committee

**January 10**

Education, Board of  
- State Special Education Advisory Committee

**January 17**

Library Board  
- Archival and Information Services Committee  
- Collection Management Services Committee  
- Legislative and Finance Committee  
- Publications and Education Services Committee  
- Public Library Development Committee  
- Records Management Committee

**January 22**

† Contractors, Board for

**January 23**

† Rehabilitative Services, Board of  
Retirement System, Virginia  
- Corporate Governance Task Force

**January 27**

Education, Board of  
- Advisory Board for Teacher Education and Licensure  
Nursing, Board of

**January 29**

Nursing, Board of

**January 30**

George Mason University  
- Board of Visitors  
Nursing, Board of

**February 6**

† Health, Department of

## **PUBLIC HEARINGS**

**November 18**

Rehabilitative Services, Department of

**November 21**

Water Control Board, State

**December 2**

† Education, Board of

**December 5**

Governor's Commission on Efficiency and Effectiveness

**December 16**

† Transportation Board, Commonwealth

**March 13, 2003**

Agriculture and Consumer Services, State Board of